

Basic Operation Guide

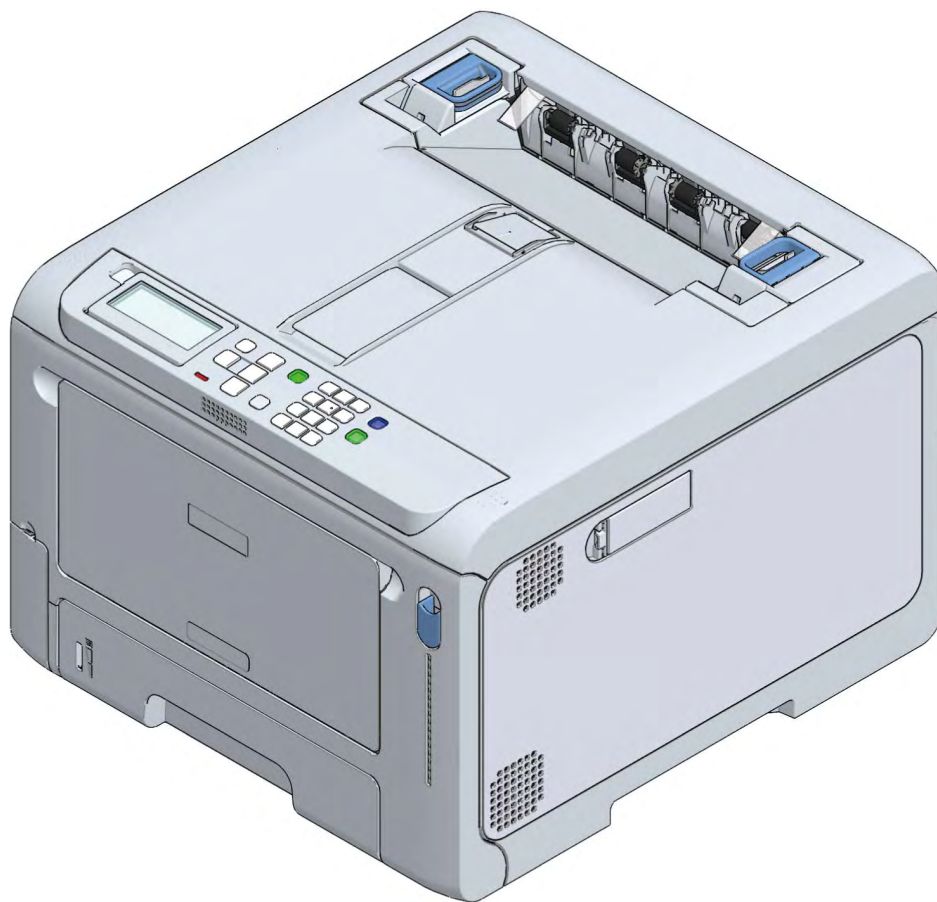

Table of Contents

1. Getting started	4	Loading paper	70
Safety precautions.....	5	Procedure for loading paper	70
General cautions	6	Applicable paper.....	70
Preface	8	Inapplicable paper	72
Trademarks	9	Paper precautions by type.....	72
About this manual.....	10	Paper applicable to each tray	74
About the description.....	10	Loading paper in Tray 1.....	74
Features of this machine.....	12	Loading paper in Tray 2/3/4 (Optional).....	76
2. Connecting to the PC after preparing this machine	13	Loading paper in the MP tray	78
Installation	14	Setting paper information on the operator panel.....	79
Installation environment	14	Storing paper.....	81
Installation space.....	14	Setting the output bin	82
Unpacking	16	Output tray.....	82
Checking accessories	18	Rear output tray.....	83
Installing the starter toner cartridge.....	19	Checking the configuration	84
Installing options.....	20	Printing the menu map (configuration).....	84
Installing the wireless LAN module.....	20	Confirming on the operator panel	85
Installing the expansion tray unit	22	How to use levers L1 and L2	86
Installing the dedicated caster stand	25	4. Changing settings from the operator panel	88
Connecting the power cord	31	Parts identification of the operator panel	89
About the power supply	31	Adjusting the display orientation	90
Loading paper in the tray	32	Inputting text.....	91
Connecting via a wired LAN.....	34	Changing settings	92
Connecting the LAN cable.....	34	Setting menu display	92
Setting the IP address, etc.	34	Setting with the short menu (Fn key).....	92
Connecting via a wireless LAN	39	Adjusting the buzzer volume	95
Connection form	39	Setting the power save function.....	96
Connecting via an access point (Infrastructure).....	40	Setting the time that elapses before entering the power save mode	96
Connecting directly with this machine (AP mode)	51	Setting the time that elapses before entering the sleep mode.....	96
Connecting via USB	56	Restrictions of the power save function.....	97
Installing software on a PC	57	Turning off the power automatically (Auto Power Off)	97
For Windows	57	Setting the time that elapses before entering the auto power off mode.....	99
For macOS.....	61	5. Printing	100
Setting the printer driver	62	Printing from a PC.....	101
3. Basic operations	65	For Windows PCL printer driver	101
Parts identification	66	For Windows PS printer driver.....	102
Front.....	66	For macOS.....	102
Inside the main unit	67	Screens and functions of the printer driver ...	103
Back	68	Windows PCL printer driver.....	103
Turning the power on/off	69	Windows PS printer driver	105
Turning the power on	69	macOS printer driver	107
Turning the power off	69	How to open the printer folder	112

6. Management of this machine	113
Admin password.....	114
Checking the factory default admin passwords	114
Inputting the factory default admin passwords	116
Changing the admin password	117
7. Maintenance	119
Precautions for replacing consumables	120
Service life and replacement cycle of consumables	121
Toner cartridge	121
Image drum	121
Replacing the black(K) toner cartridge and the waste toner box	123
Replacing the toner cartridge (C/M/Y).....	126
Replacing the image drum	128
Service life and replacement cycle of maintenance parts.....	131
Belt unit	131
Fuser unit	132
Replacing the belt unit.....	133
Replacing the fuser unit	135
Cleaning the main unit and the parts	137
Cleaning the LED head	137
Cleaning the surface of the main unit	138
Cleaning paper feed rollers (Trays 1-4).....	139
Cleaning the paper feed roller (MP tray).....	140
Cleaning the light-shielding film.....	144
Cleaning the resist roller	145
8. Troubleshooting.....	146
When an error message appears on the display	147
When paper is jammed	148
For the error code 370 or 371.....	148
For the error code 372.....	151
For the error code 380.....	153
For the error code 381.....	154
For the error code 382 or 385.....	155
For the error code 390.....	159
For the error code 391, 392, 393 or 394.....	159
For the error code 638.....	161
Appendix.....	166
Specifications	167
Regulatory wireless LAN statements.....	169
Dimensions.....	171
Menu tree	173



1

Getting started

















Safety precautions.....	5
General cautions	6
Preface	8
Trademarks	9
About this manual.....	10
Features of this machine	12

Safety precautions



Read this manual for your safety before using the product.

 WARNING	Mishandling due to ignoring this display may cause death or serious injury.
 CAUTION	Mishandling due to ignoring this display may cause personal injury.

General cautions

 WARNING	
	Do not touch the safety switch inside the machine. Doing so may cause electric shock when high voltage occurs. In addition, gears can rotate, which may result in personal injury.
	Do not use an inflammable spray near the machine. Doing so may cause a fire since there is an area heating up within the machine.
	Unplug the power cord from the outlet and contact your dealer if the cover becomes abnormally hot, emits smoke, smells strange, or makes an abnormal noise. Failure to do so may cause fire.
	Unplug the power cord from the outlet and contact your dealer if water or other liquid gets into the machine. Failure to do so may cause fire.
	If paper clips or other foreign objects enter the machine, disconnect the power plug from the outlet and remove foreign objects if any. Failure to do so may cause electric shock, fire or injury.
	Do not disassemble the machine or perform operations other than those specified in the User's Manual. Doing so may cause electric shock, fire or injury.
	Unplug the power cord from the outlet and contact your dealer if the machine is dropped or the cover is damaged. Failure to do so may cause electric shock, fire or injury.
	Periodically disconnect the power plug from the outlet and clean the base of the prongs and between the prongs. Leaving the power plug inside the outlet for a long period of time may cause a fire due to short circuit caused by collection of dust at the base of the prongs.
	Do not clean up spilled toner using an electric vacuum cleaner. When spilled toner is cleaned up using an electric vacuum cleaner, a fire may be caused due to sparks from electrical contacts. If toner is spilled on the floor, wipe the toner up carefully using a damp cloth to prevent toner scattering.
	Do not insert objects into the air vents. Doing so may cause electric shock, fire or injury.
	Do not place any containers like cups containing water on the machine. Doing so may cause electric shock or fire.
	Make sure that no urine from pets on top of the printer wet or enter this machine. Failure to do so may cause electric shock or fire.
	Take care when touching the fuser unit. Failure to do so may cause burns.
	Do not throw the image drum, toner cartridge or waste toner box into fire. Doing so may cause burns due to dust explosion.
	Do not connect the power cord, cables and ground wire other than those specified in the User's Manual. Doing so may cause a fire.
	Operations using an uninterruptible power supply (UPS) or an inverter are not guaranteed. Do not use an uninterruptible power supply or inverter. Doing so may cause a fire.

 **CAUTION**

	Do not approach the paper discharger when the power is on or during printing. Doing so may cause injury.
	Do not touch a broken display. Doing so may cause injury. If any liquid (liquid crystal) leaking from the display gets into the eyes or mouth, wash it off promptly with a large quantity of water. Consult a physician as necessary.
	Do not disassemble or forcibly open the image drum, toner cartridge or waste toner box. Doing so may scatter the toner, which may be inhaled by people or may stain clothes or hands.

NOTE!

This product is not intended for use in the immediate visual field on the display work place. To avoid disturbing reflections on the display work place, this product shall not be placed in the immediate field of vision.

Preface

• EMERGENCY FIRST AID

Take care with toner powder:



If swallowed, give small amounts of cold water and seek medical attention. DO NOT attempt to induce vomiting.

If inhaled, move the person to an open area for fresh air. Seek medical attention.

If it gets into the eyes, flush with large amounts of water for at least 15 minutes keeping eyelids open. Seek medical attention.

Spillages should be treated with cold water and soap to help reduce risk of staining skin or clothing.

• ENVIRONMENTAL INFORMATION



Trademarks

OKI is a registered trademark of Oki Electric Industry Co., Ltd.

ENERGY STAR® is a trademark of the United States Environmental Protection Agency.

Microsoft, Windows, Windows Server and Internet Explorer are registered trademarks or trademarks of Microsoft Corporation in the United States and other countries.

Apple, Mac, macOS, iPad, iPhone, iPod, iPod Touch and Safari are registered trademarks of Apple Inc. in the United States and other countries.



AirPrint and the AirPrint logo are trademarks of Apple Inc.

Google, Google Chrome, Android and Gmail are trademarks or registered trademarks of Google LLC.

iOS is a trademark of Cisco.

Adobe, Illustrator, Photoshop, PostScript and Reader are registered trademarks or trademarks of Adobe Systems Incorporated in the United States and other countries.

Wi-Fi is a registered trademark of Wi-Fi Alliance.

Other product names and brand names are registered trademarks or trademarks of their proprietors.

	<p>As an ENERGY STAR® Program Participant, the manufacturer has determined that this product meets the ENERGY STAR® guidelines for energy efficiency.</p> <p>Target countries of the ENERGY STAR® program are the United States, Canada and Japan.</p> <p>It is not applicable to other countries.</p>
	<p>This product complies with the requirements of the Council Directives 2014/30/EU (EMC), 2014/35/EU(LVD), 2014/53/EU (RED), 2009/125/EC (ErP) and 2011/65/EU(RoHS), as amended where applicable, on the approximation of the laws of the member states relating to Electromagnetic Compatibility, Low Voltage, Radio Equipment, Energy related Products and Restriction on the use of certain Hazardous Substances in electrical and electronic equipment.</p>

The following cables were used to evaluate this product for EMC directive 2014/30/EU compliance, and configurations other than this may affect that compliance.

CABLE TYPE	LENGTH (METER)	CORE	SHIELD
Power	1.8	✗	✗
USB	5.0	✗	✓
LAN	10.0	✗	✗

The simplified EU declaration of conformity

Hereby, Oki Electric Industry Co., Ltd. declares that the radio equipment type "AW-CM382" is in compliance with Directive 2014/53/EU.

The full text of the EU declaration of conformity is available at the following internet address:

<https://www.oki.com/eu/printing/support/declaration-of-conformity>

About this manual

This section lists a variety of information about this manual. Please read this manual before using the machine.



- Depending on the target region or country, specifications and functions of the product may differ from those described in the manual. Please check the menu items and default settings with the device you are using.

Manual structure

- Basic Operation Guide (PDF)...included on the DVD enclosed with this machine.
- User's Manual (PDF)...available on the website.
- Online Manual...available on the website.

About this manual

- The reproduction of this manual, in whole or in part, without permission is strictly prohibited.
- The content of this manual may be changed without a prior notice in the future.
- Efforts have been exerted to make the content of this manual as complete as possible. However, should you notice any errors, omissions or other problems, contact the retail store where you made the purchase.
- Notwithstanding the foregoing, we shall not have any liability in regard to any operational effect related to the instructions contained in this manual.

Copyrights

All rights belong to Oki Electric Industry Co., Ltd. This manual may not be reproduced, transcribed or translated without permission. Be sure to obtain the written approval from Oki Electric Industry Co., Ltd.

© 2020 Oki Electric Industry Co., Ltd.

About the description

This section describes the marks, symbols, abbreviations and illustrations used in this manual.



- This manual uses screens of the following operating systems unless otherwise specified.
For Windows: Windows 10
For macOS: macOS 10.15
- Sometimes, the model name is written as [OKI Printer].
- Depending on the used OS, model and version, the description in this manual may differ.

About marks

This manual uses the following marks.

Mark	Meaning
	Indicates cautions and restrictions for the correct operation of this machine. Be sure to read them to avoid misoperation.
	Indicates useful tips and references on how to use this machine. We recommend you read them.
	Indicates reference items. Please read them to learn the detailed information.
	Indicates the related items. Please read them to learn the relevant information.

About symbols

This section describes the symbols used in this manual and their meanings.

Symbol	Meaning
« »	Indicates buttons/keys on the operator panel of this machine. Indicates keys on the PC keyboard.
[]	Indicates menu names, item names, options, etc. displayed on the display. Indicates menus, windows and dialog box names displayed on the PC screen. They can be clearly distinguished in the description and procedure illustration.
" "	Indicates messages and input texts displayed on the display. Indicates file names on the PC. Indicates item titles of link destinations.
-	Indicates the menu path of this machine or the PC.

Features of this machine

- **Installable in restrained space**

As the machine is compact, the space between both sides of this machine and the wall can be as small as 20 mm. (When the optional caster stand is not installed)

- **Easy maintenance with full front access**

You can replace consumables and maintenance parts, and clear a paper jam from the front side.

- **An increased service life of the machine and consumables**

The service life of this machine and the image drum has been extended in comparison with existing models.

- **Immediate start of printing thanks to short warm-up time**

The warm-up time of this machine has been shortened in comparison with conventional models.

- **Massive printing possible with the extension tray**

Up to three extension trays can be installed.

- **Easy troubleshooting by watching the display**

The troubleshooting hint is displayed together with illustrations on the display. You can solve problems by following the on-screen instructions.

- **Easy setting change by shortcut menus**

Menu items can be displayed easily by pressing the «Fn» key and then inputting a number.

 [Setting with the short menu \(Fn key\)\(P.92\)](#)

- **Easy update by using the Monitoring Tool**

You can update the firmware and the software easily by using the Monitoring Tool.

- **Easy mobile printing and initialization with the NFC and app**

You can print and initialize this machine by using the specialized application from your smartphone, tablet or other mobile devices.

 [Applications for mobile devices \(User's Manual\)](#)

2

Connecting to the PC after preparing this machine

Installation	14
Unpacking	16
Checking accessories	18
Installing the starter toner cartridge.....	19
Installing options.....	20
Connecting the power cord	31
Loading paper in the tray	32
Connecting via a wired LAN.....	34
Connecting via a wireless LAN	39
Connecting via USB	56
Installing software on a PC	57

Installation

Installation environment

Install this machine in the following environment.

Ambient temperature: 10°C to 32°C

Ambient humidity: 20% to 80% RH (relative humidity)

Maximum wet-bulb temperature: 25°C



- Make sure there is no condensation. Failure to do so may cause a malfunction.
- To install this machine in a location where the ambient humidity is 30% RH or less, use a humidifier or static prevention mat.
- Depending on the installation environment, the operating noise of this machine may cause concern. If you are concerned about the operating noise, we recommend that you install this machine in an isolated location or a separate room.
- Do not install this machine near any devices in which combustion takes place. Doing so may cause lighter printing.

WARNING

- Do not install this machine close to high-temperature locations or naked flames.
- Do not install in locations where chemical reactions occur (e.g. laboratories).
- Do not install this machine close to combustible solutions such as alcohol and thinners.
- Do not install this machine within the reach of children or infants.
- Do not install this machine in an unstable location (e.g. unsteady table or sloping surface).
- Do not install this machine in a humid or dusty location, or in a location exposed to direct sunlight.
- Do not install this machine in an environment with salt air, corrosive gas, NOx, or SOx.
- Do not install this machine in locations with major vibration.
- Do not install this machine in locations where its air vents are blocked.

CAUTION

- Do not directly install this machine on shaggy rugs or carpets.
- Do not install this machine in locations with poor air circulation or ventilation like in a sealed room.
- Ensure proper ventilation when it is used for a long time in a small room.
- Keep this machine away from strong magnetic fields and sources of noise.
- Keep this machine away from monitors and TVs.
- When moving this machine, stand at the front and back and hold the handle at the bottom of the machine.

Installation space

Install this machine on a flat desk which is larger than the bottom of the machine.

Allow sufficient space around this machine as shown in the following figures.

- Plan view (When the optional caster stand is not installed)

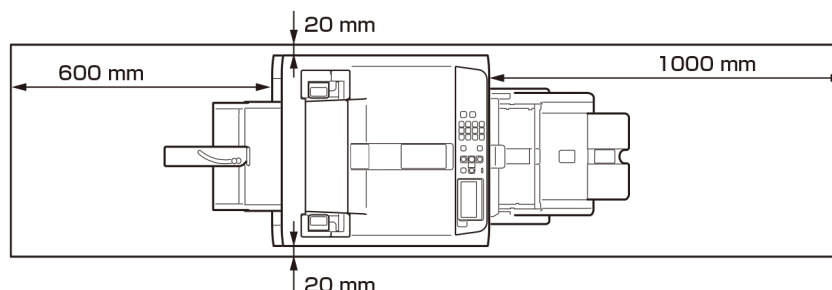

- Side view (When the rear output tray is used)

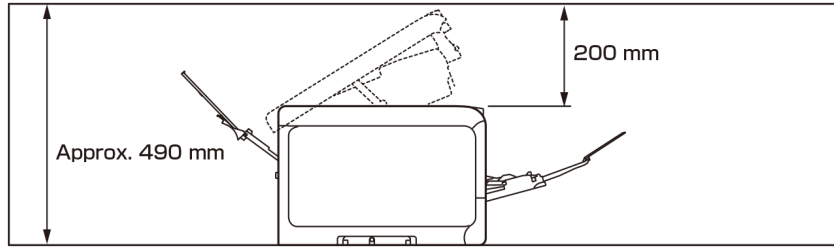

- Depending on the installation environment, the temperature inside this machine may rise and the printing speed may slow down.

- Side view (When the rear output tray is closed and a cable with angled connector is used)

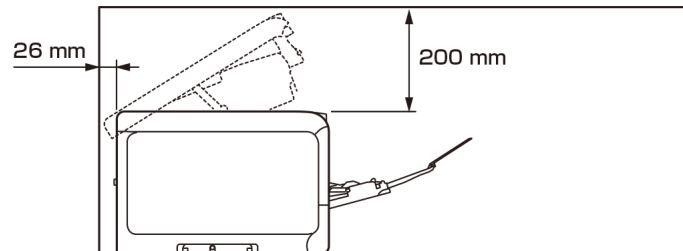

- Depending on the installation environment, the temperature inside this machine may rise and the printing speed may slow down.
- Do not place curtains, paper or other flammable objects on the back of this machine.

Unpacking



Doing so may cause injury.



This machine weighs approx. 30 kg, so be sure to have it lifted by at least 2 persons.



- Be sure to use the consumables/maintenance items supplied with this machine first. If you install the consumables/maintenance items other than those supplied first, the lifespan may not be displayed correctly or the accessories may not be usable later.
- Because image drums (green parts) can easily get damaged, handle with adequate care.
- Do not expose the image drum to direct sunlight or strong light exceeding approx. 1,500 lux. Do not leave it for more than 5 minutes even under room lighting.
- Do not expose the removed fuser unit to direct sunlight or strong light exceeding approx. 1,500 lux. Do not leave it uncovered for more than 5 minutes even under room lighting.
- The packing box and buffer material are required when shipping this machine. Do not discard them, but store them safely.

1 Open the packing box and take out the accessories and buffer material.

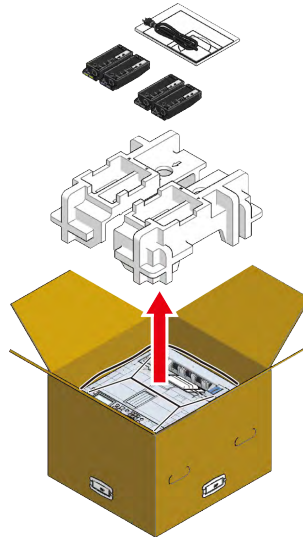

2 Remove the packing case and take out this machine from the plastic bag.

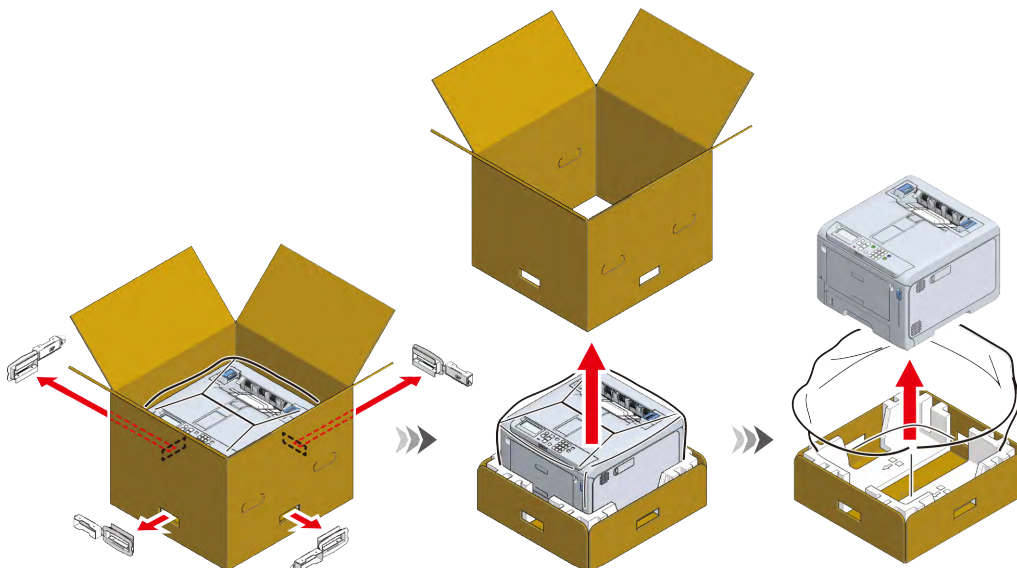

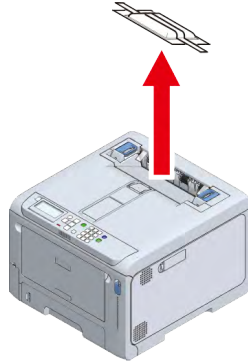

- 3 Lift this machine and place it at the installation site.
- 4 Remove the drying agent on the top of this machine.



- To use the optional expansion tray, see "[Installing options](#)(P.20)".

Checking accessories

Make sure that you have all the following accessories.

 CAUTION	Doing so may cause injury.	
This machine weighs approx. 30 kg, so be sure to have it lifted by at least 2 personals.		



- See "[Unpacking\(P.16\)](#)" for the unpacking method.



- Be sure to use the consumables enclosed with this machine first. If you install consumables other than the accessories first, the service life may not be displayed correctly, or the accessories may not be usable later.

- Main unit



- By default, an image drum and a waste toner box are installed in the main unit.

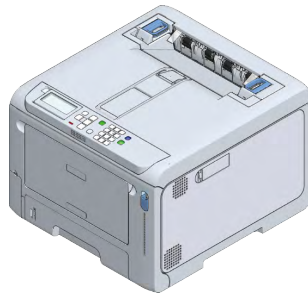

- 4 starter toner cartridges (black, cyan, magenta, and yellow)



- Setup Guide

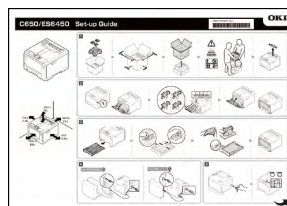

- DVD



- Power cord



- The LAN cable and USB cable are not included. Please prepare a cable separately according to the connection environment.

 [Connecting via a wired LAN\(P.34\)](#)

 [Connecting via USB\(P.56\)](#)

Installing the starter toner cartridge



- When you use this machine for the first time, install the included starter toner cartridge. If an optional toner cartridge is installed and used first, you may not be able to use the starter cartridge later.
- Do not install a starter toner cartridge that has been used in another machine. The remaining toner may not be displayed correctly.

- 1** Pull the front cover open lever (blue) to open the front cover.

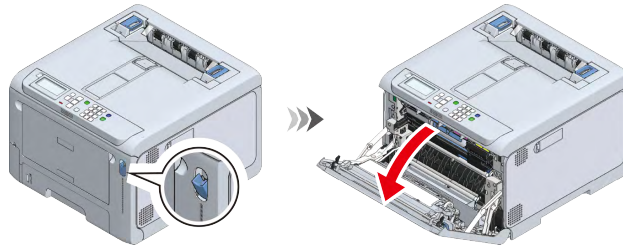

- 2** Take the black(K) starter toner cartridge out of the bag, and shake it several times vertically or horizontally.



- 3** Install the black(K) starter toner cartridge in the machine.

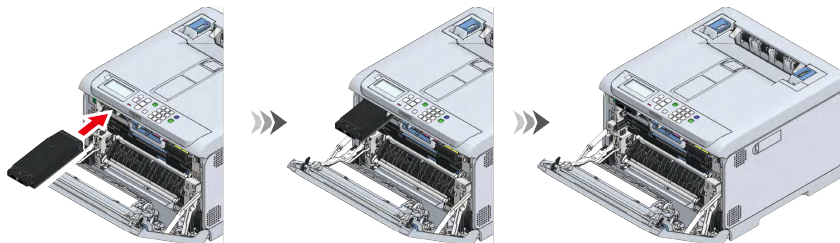

- 4** Install the starter toner cartridge (C/M/Y) in the same way as the black(K) starter toner cartridge.

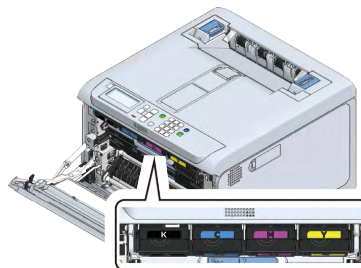

- 5** Close the front cover firmly with both hands.

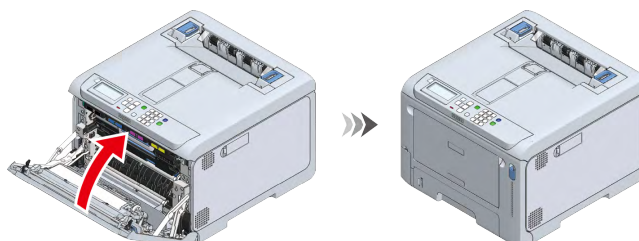

Installing options

This section explains the installation of options. If no option is installed, proceed to "[Connecting the power cord\(P.31\)](#)".

The following options are available.



- Be sure to turn off the power and unplug the power cord and cables before installing any options. If an option is installed with the power on, the main unit and the option may be damaged.

- Wireless LAN module

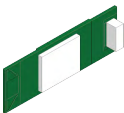
	Description
	Install it when you want to use this machine via a wireless LAN.

- Expansion tray unit

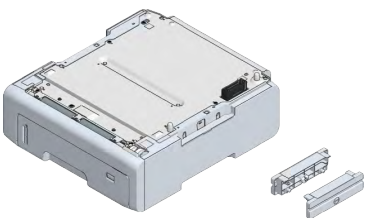
	Description
	Install it to increase the quantity of paper that can be loaded in this machine. Up to 3 levels can be expanded.

- Dedicated caster stand

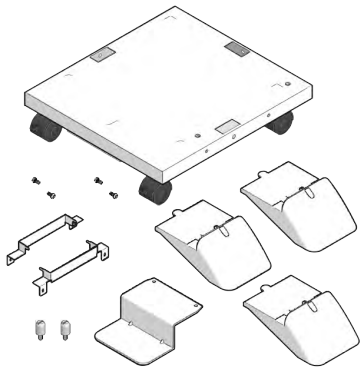
	Description
	With it installed, the machine is easier to move. After moving, fix with a stopper.



- After mounting the optional expansion tray unit, install the software on your PC, and set the options from the printer driver. See "[Setting the printer driver\(P.62\)](#)".

Installing the wireless LAN module

Install it when you want to use this machine via a wireless LAN. After installation, it is required to follow the procedure to enable the wireless LAN module.

This section describes the procedure of installing the wireless LAN module and enabling it from the operator panel.

Ethernet and wireless LAN can be used simultaneously on different networks.

Model: 45830222

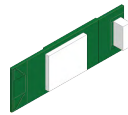

1 Turn off this machine and unplug the power cord.



- If you install it with the power on, the main unit or wireless LAN module may be damaged.

 [Turning the power off\(P.69\)](#)

2 Open the wireless LAN module cover on the side of this machine.

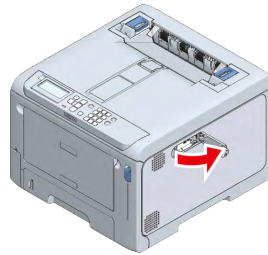

3 Pull out the connector and insert it into the wireless LAN module.

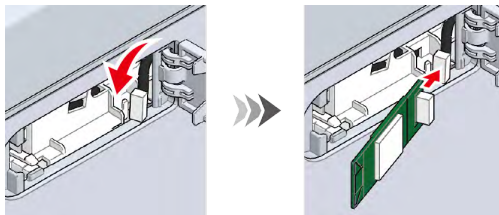

4 Insert the wireless LAN module into this machine.

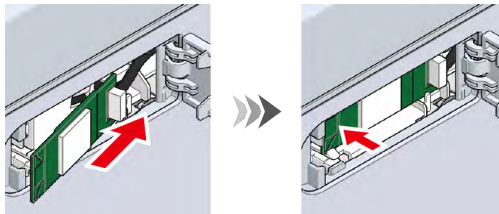

5 Close the wireless LAN module cover.

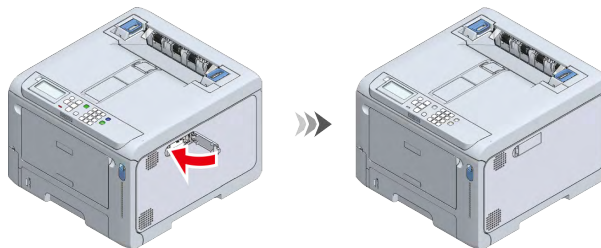

6 Connect the power cord to this machine.

 [Connecting the power cord\(P.31\)](#)

7 Power on this machine.

8 Press the scroll button ▼ on the operator panel several times to select [Admin Setup], and press «OK».

- 9 Input the admin password using the numeric keypad, and press «OK».

[Admin password\(P.114\)](#)

- 10 Check that [Network Setup] is selected, and press «OK».

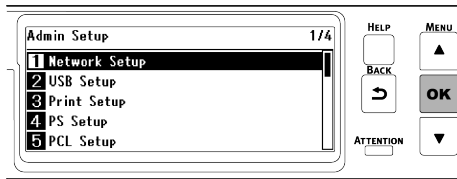

- 11 Check that [General Setup] is selected, and press «OK».

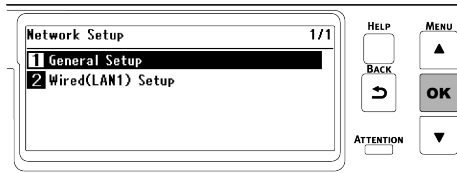

- 12 Check that [Extended Network] is selected, and press «OK».

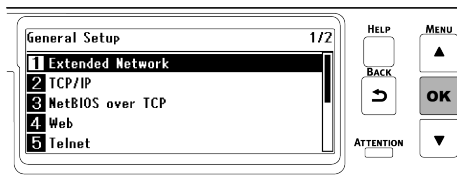

- 13 Press ▼ to select [Wireless], and press «OK».

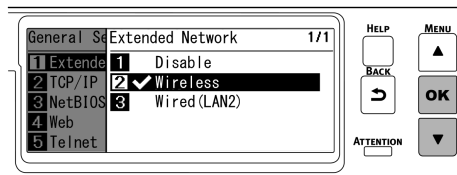

- 14 When [Are You Sure?] is displayed, check that [Yes] is selected, and press «OK».

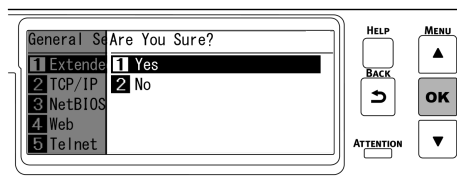

- 15 Wait until the standby screen appears as this machine restarts.

- 16 Enable [Wireless(Infrastructure)] or [Wireless(AP Mode)].

[Connecting via a wireless LAN\(P.39\)](#)



- [Wireless(Infrastructure)] and [Wireless(AP Mode)] cannot be enabled at the same time.

Installing the expansion tray unit



Doing so may cause injury.



This machine may fall over. Be sure to install the attached fixing parts.
To use the dedicated caster stand, be sure to mount the anti-tip feet.

Install the expansion tray unit to increase the quantity of paper that can be loaded. After installation, set the number of trays in the printer driver.

Up to three extension trays can be installed. Be sure to install the attached fixing parts.

To install any of the three expansion trays, it is recommended to install the optional dedicated caster stand to avoid the risk of tipping. Be sure to mount the anti-tip feet.

[Installing the dedicated caster stand\(P.25\)](#)

A flat-head screwdriver is required to install the expansion tray unit.



- The packing case and buffer materials are required to ship the expansion tray. Do not discard them, but store them safely.
- When an extension tray is used to print from, if the printing position shifts, correct the printing position for each extension tray. For details, see "Correcting the print position of the tray (User's Manual)".

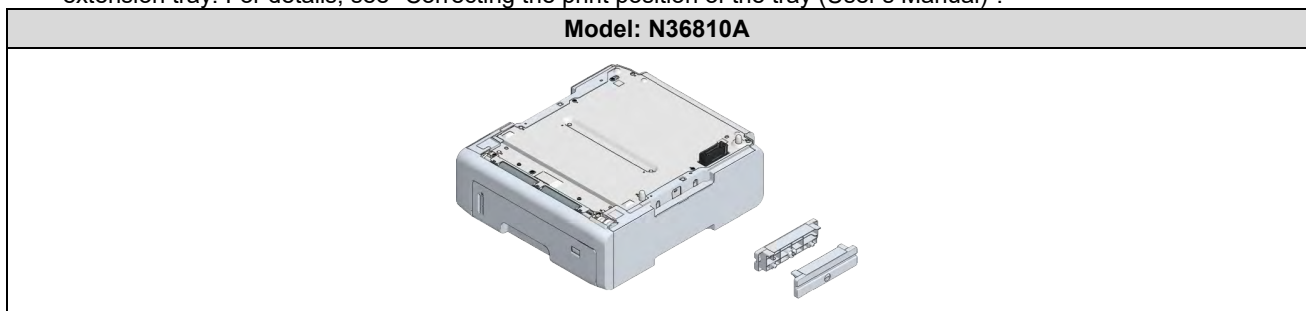

CAUTION	Doing so may cause injury.	
This machine weighs approx. 30 kg, so be sure to have it lifted by at least 2 persons.		

This section describes the installation of two expansion tray units as an example.

1 Turn off this machine and remove the power cord and all the cables.



- Be sure to turn off the power and unplug the power cord and all the cables before installing the expansion tray unit. If the expansion tray unit is installed with the power on, this machine and the expansion tray unit may be damaged.
- Installation with a cable connected may cause you to get caught in the cable and get injured.

2 Install one expansion tray.

3 Gently stack the additional expansion tray on the expansion tray installed in Step 2 so that they are aligned on the right side and front and the protrusions fit into the holes on the bottom.

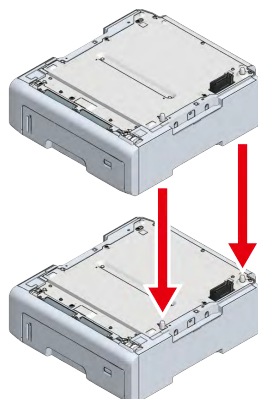

- 4 Fix the stacked expansion trays on both sides with accessories by using a flat-head screwdriver.

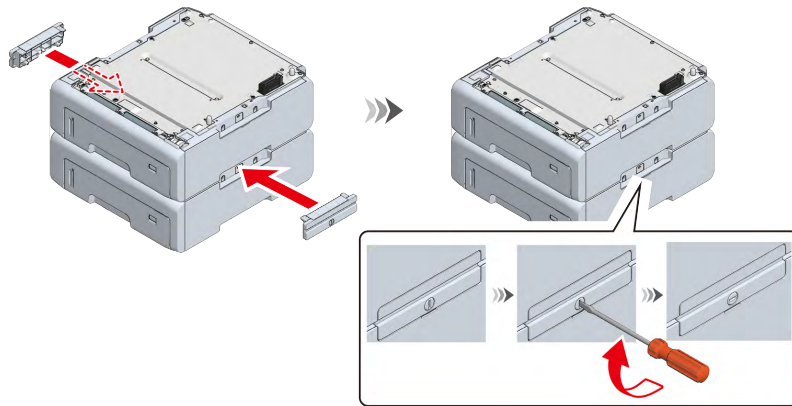

- 5 With the main unit and the expansion trays aligned on the right side and front, gently stack them so that the protrusions of the expansion tray fit into the holes on the bottom of the main unit.

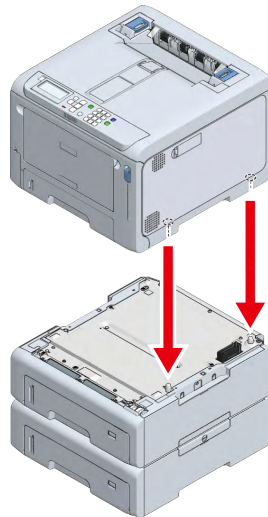

- 6 Fix the main unit and the expansion trays by using a flat-head screwdriver.

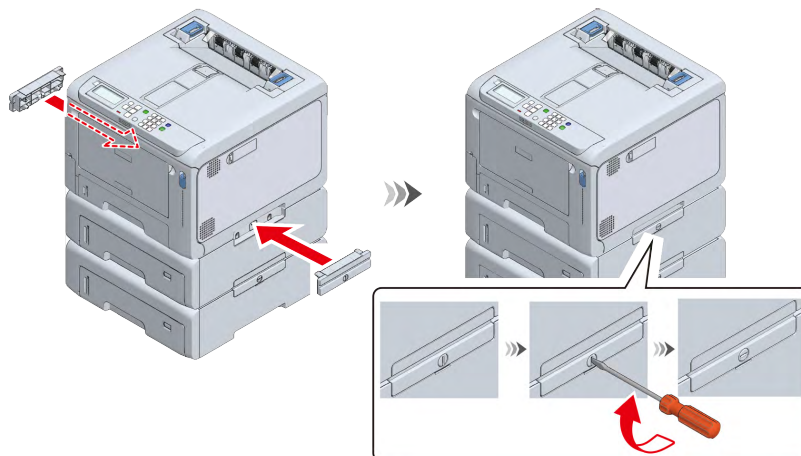

- When transporting this machine, replacing consumables or maintenance parts, or loading paper in the tray, check the following points to avoid the risk of tipping.

- Do not press on the back of this machine or the image drum basket when the output tray is open and the image drum is pulled out.

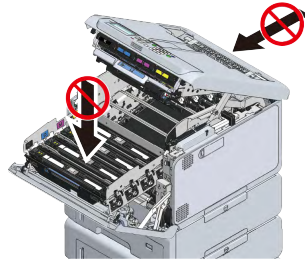

- Do not press on the cassette from above when the cassette is pulled out.

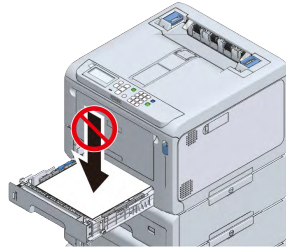

- Do not press on this machine from the back with the cassette pulled out.

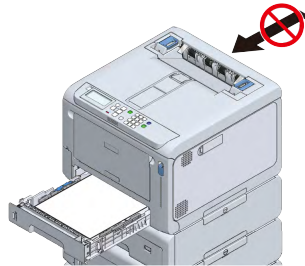

- 7 Plug in the power cord and the disconnected cable back to the main unit.
[Connecting the power cord](#)(P.31)
- 8 Power on this machine.
- 9 Press the scroll button ▼ on the operator panel several times to select [Configuration], and press «OK».
- 10 Check that [Tray Count] is selected, and press «OK».
- 11 Make sure the display shows the installed expansion tray.
- 12 After confirming the content, press «ONLINE» to return to the standby screen.
- 13 After connecting this machine to a PC and completing software installation, set the expansion tray unit in the printer driver.
[Setting the printer driver](#)(P.62)

Installing the dedicated caster stand



CAUTION

Doing so may cause injury.



This machine may fall over. Be sure to install the attached fixing parts.
To install any of the three expansion trays, be sure to mount the anti-tip feet.

This is a stand with casters for moving this machine.

It also comes with anti-tip feet to avoid the risk of tipping. It is recommended to use it when the expansion tray is installed.

A Phillips-head screwdriver and a flat-head screwdriver are required to install the caster stand.



- To install any of the three expansion trays is installed, be sure to install the dedicated caster stand, the anti-tip feet and the attached fixing parts to avoid the risk of tipping.
- The packing box and buffer materials are required to ship the dedicated caster stand. Do not discard them, but store them safely.

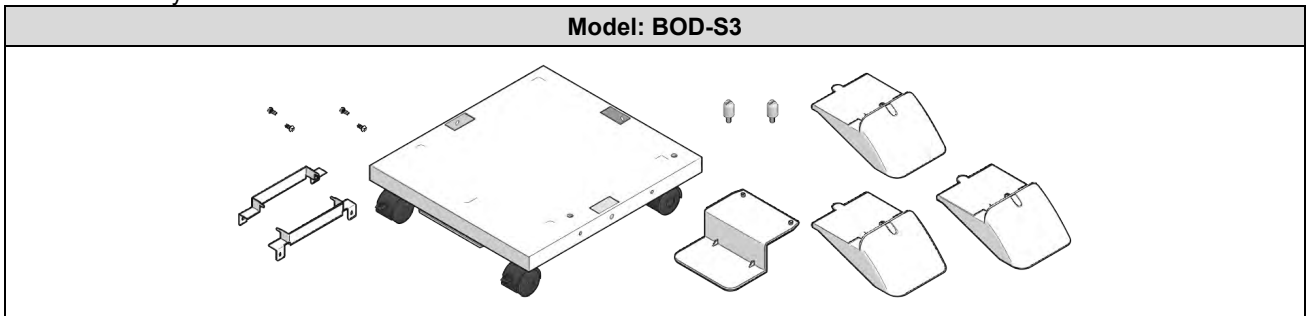

Doing so may cause injury.



This machine weighs approx. 30 kg, so be sure to have it lifted by at least 2 persons.

1 Check that you have all the parts for the dedicated caster stand.

- (1) Main unit
- (2) Anti-tip foot a
- (3) Anti-tip foot b (x 3)
- (4) Positioning pin (x 2)
- (5) Metal fixtures of the caster stand (x 2)
- (6) Screw (x 4)

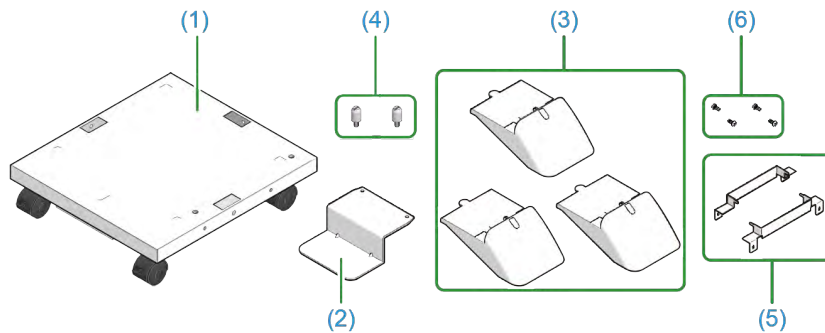

2 Mount the anti-tip foot a on the front of the dedicated caster stand.

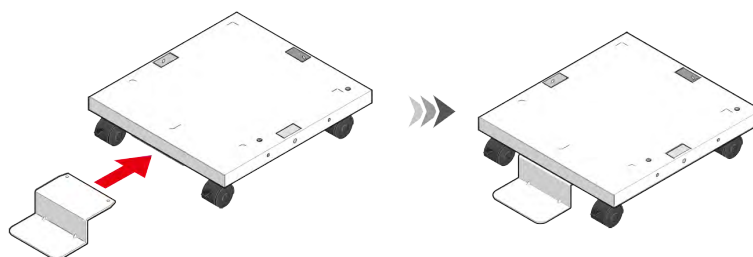

- 3 Then, mount the anti-tip foot b (x 3) to both sides and the back.

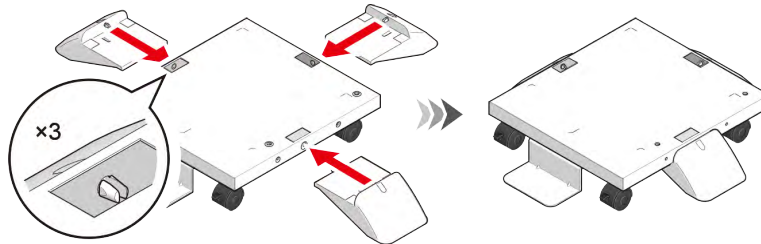

- 4 Check that the anti-tip foot a and the anti-tip foot b (x 3) are inserted in place by turning the dedicated caster stand upside down.

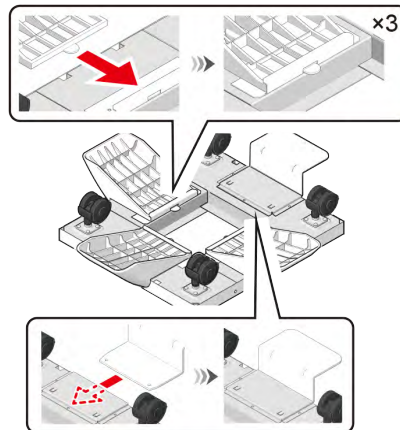

- 5 Turn the dedicated caster stand back and mount the positioning pin (x 2). Rotate to fix the positioning pin (x 2) with a flat-head screwdriver.

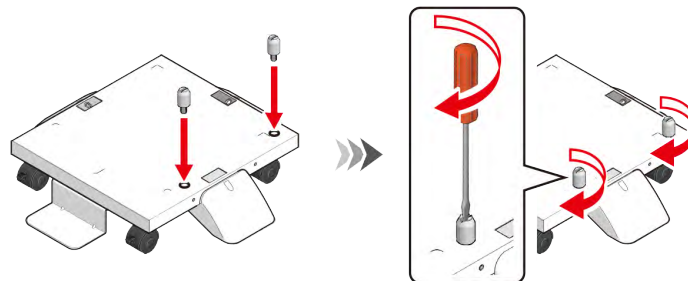

- 6 Turn off this machine and remove the power cord and all cables.



- Installation with a cable connected may cause you to get caught in the cable and get injured.

- 7 Lock the caster (2 places) to prevent the dedicated caster from moving during the installation of the main unit and the expansion tray.

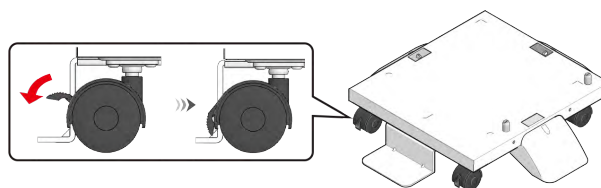

- 8** With the main unit or the expansion tray aligned with the dedicated caster on the right side and the front, gently stack them so that the positioning pins of the dedicated caster stand fit into the holes on the bottom.

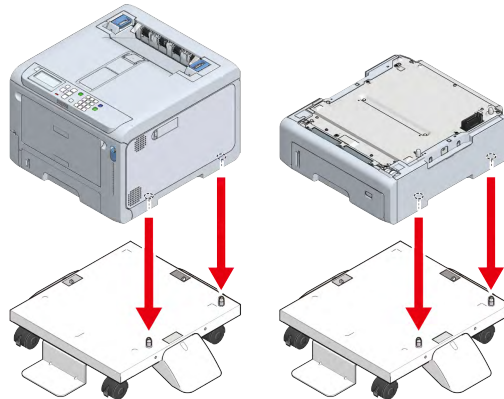

- 9** Fix the main unit or the extension tray and the dedicated caster stand with the metal fixtures (x 2) and the screws (x 4) by using a Phillips-head screwdriver. The figure shows an example of fixing the expansion tray and the dedicated caster stand.

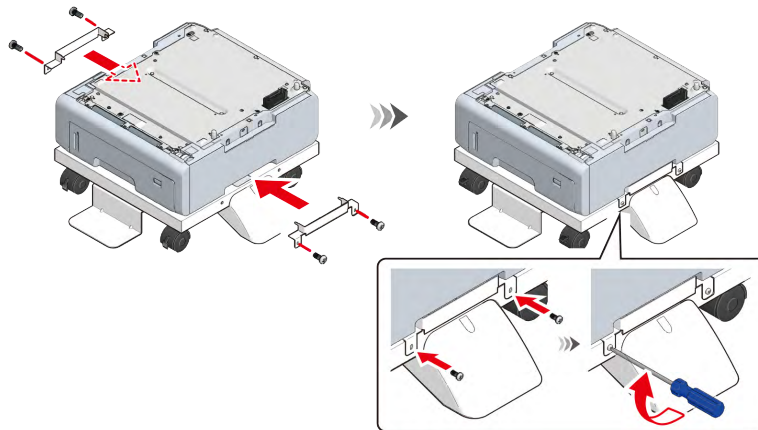

- 10** To add more extension trays, with the expansion tray already attached onto the dedicated caster stand aligned with the expansion tray to be installed on the right side and front, gently stack them so that the protrusions fit into the holes on the bottom.

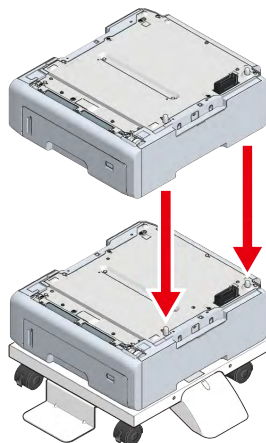

- 11** Fix the stacked expansion trays on both sides with accessories by using a flat-head screwdriver.

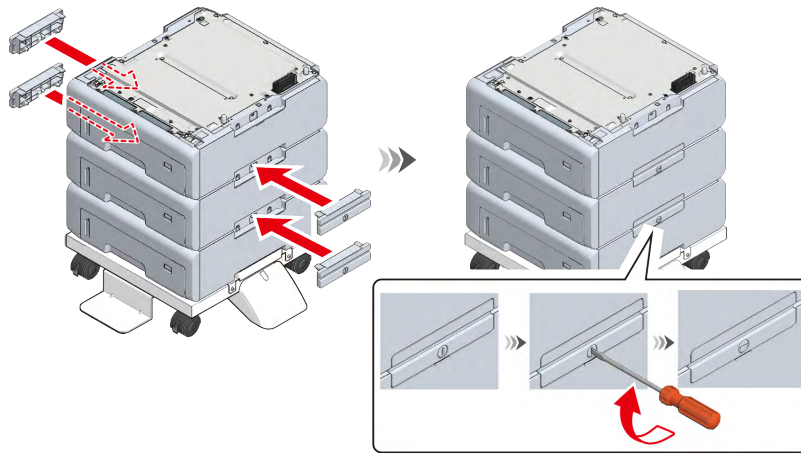

- 12** When multiple expansion trays are installed, with the main unit and the expansion trays aligned on the right side and front, gently stack them so that the protrusions of the expansion tray fit into the holes on the bottom of the main unit.

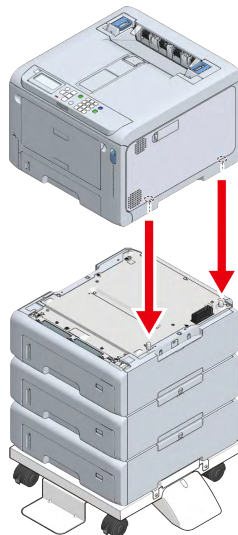

- 13** When the expansion tray is installed, fix the main unit and the expansion tray on both sides with accessories by using a flat-head screwdriver.

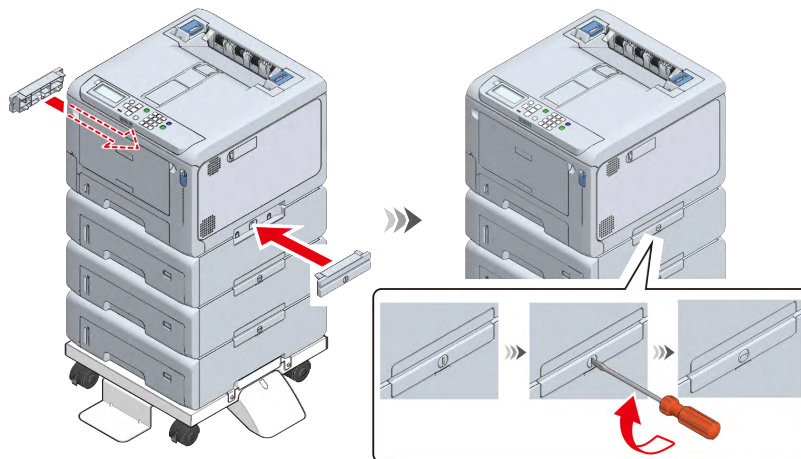

14 Before moving this machine, unlock the casters (2 places).

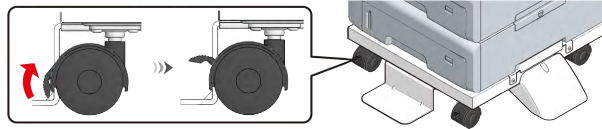

15 After moving this machine, lock the casters (2 places) to prevent accidental sliding.

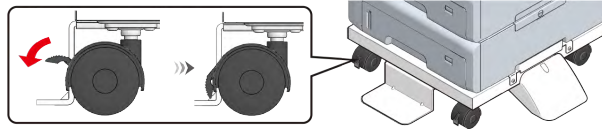

- When transporting this machine, replacing consumables or maintenance parts, or loading paper in the tray, check the following points to avoid the risk of tipping.
 - Do not press on the back of this machine or the image drum basket when the output tray is open and the image drum is pulled out.

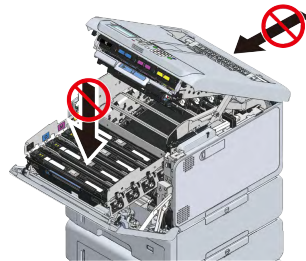

- Do not press on the cassette from above when the cassette is pulled out.

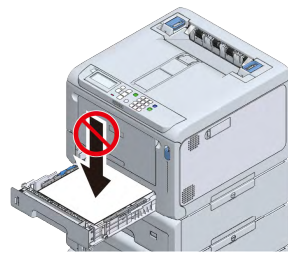

- Do not press on this machine from the back with the cassette pulled out.

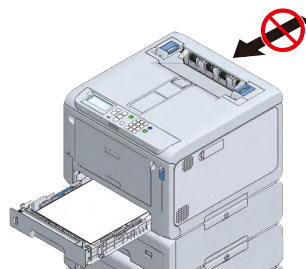

16 Plug in the power cord and the disconnected cable back to this machine.

17 Power on this machine.

When an expansion tray unit is installed, it is required to check the installation and set the printer driver.

[Setting the printer driver](#)(P.62)

Connecting the power cord

About the power supply



The power supply must meet the following requirements.

Voltage: 110 to 127V AC (Range 99 to 140V AC) / 220 to 240V AC (Range 198 to 264V AC)

Power supply frequency: 50/60 Hz \pm 2%



- If the power supply is unstable, use a voltage regulator.
- The maximum power consumption of this machine is 1,150W. Check that there is sufficient voltage capacity.
- This machine may not work properly if an uninterruptable power supply (UPS) or inverter is used. Do not use any uninterruptable power supply or inverter.

 WARNING	Doing so may cause fire or electric shock.	
<ul style="list-style-type: none"> • Be sure to turn off the power before connecting or disconnecting the power cord or ground wire. • Be sure to insert the ground wire into the dedicated ground connector. If you cannot connect to the ground, please consult your dealer. • Do not connect the ground wire to any water pipe, gas pipe, telephone ground line, lightning rod, etc. • Be sure to connect the ground wire before connecting the power cord to an outlet. Yet, be sure to disconnect the ground wire after disconnecting the power cord from the outlet. • Be sure to hold the power plug when plugging or unplugging the power cord. • Insert the power cord fully into the outlet. • Do not plug or unplug the power cord with wet hands. • Do not route the power cord wherever it could be stepped on. Also, do not place anything heavy on the power cord. • Do not bundle or tie the power cord during use. • Do not use the power cord if damaged. • Do not use any multi-outlet power strips. • Do not plug this machine and other electric devices to the same outlet. Particularly, if connected to the same outlet with air-conditionings, copiers, shredders, this machine may malfunction due to electric noise. If they have to share a same outlet, use a commercially available noise filter or noise cut transformer. • Plug the power cord that comes with this machine directly to the outlet. Do not use the power cord for other devices with this machine. • Do not use any extension cord. If you have to use an extension cord, use one with a rating of 15A or above. • If an extension cord is used, this machine may malfunction due to lower AC voltage. • Do not turn off the power or unplug the power cord during printing. • Unplug the power cord if you are not going to use the machine for a long time due to a vacation or traveling. • Do not use the power cord that comes with this machine with other devices. 		

- 1 Insert the power cable into the power connector of this machine.

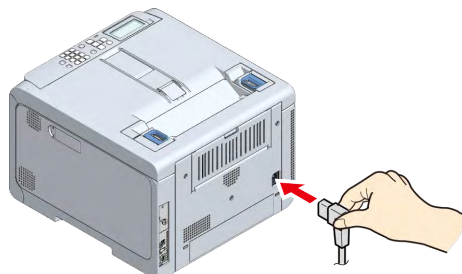

- 2 Insert the power plug into the outlet.

Loading paper in the tray

This section describes the procedure assuming that A4-sized plain paper is loaded in Tray 1. When other paper is loaded, see "[Loading paper\(P.70\)](#)".

- 1 Pull out the paper cassette.

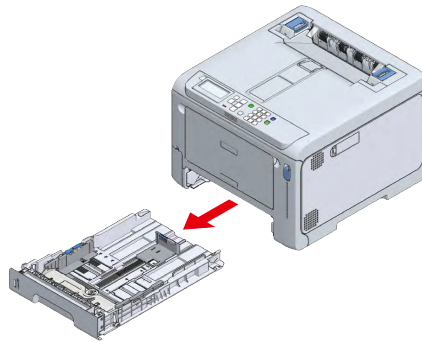

- 2 Slide the paper guide and the blue part of the paper stopper to fit the size of the paper to be loaded.

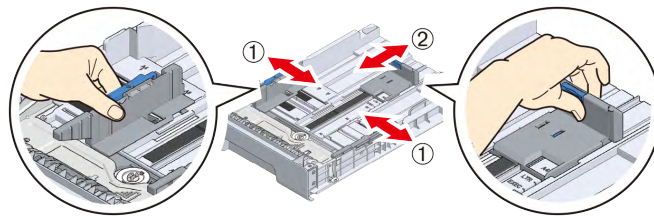

- 3 Shuffle the paper well. Straighten the edges of the paper horizontally.

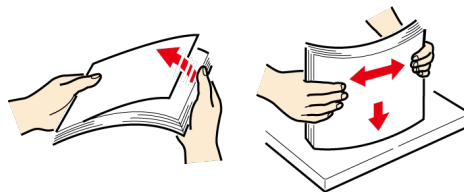

- 4 Load the paper with the printing side down, and press it down from top.



- Do not exceed the ▽ mark on the paper guide when loading paper.

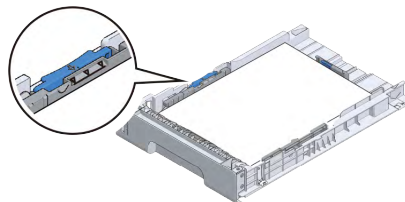

- 5 Return the paper cassette to this machine.

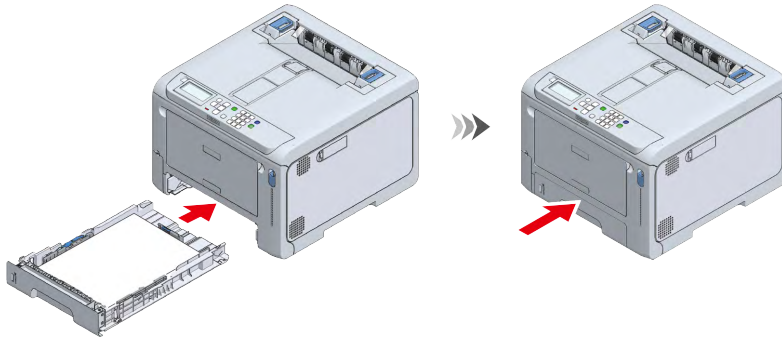

- 6 Set the size, type and weight of the paper on the operator panel.
[Loading paper\(P.70\)](#)

Connecting via a wired LAN

Connect this machine and a PC with a LAN cable to print. Connect the LAN cable, and set the IP address and others on the operator panel.

Connecting the LAN cable

- 1 Prepare a LAN cable (category 5e or better, twisted pair, straight) and a hub.

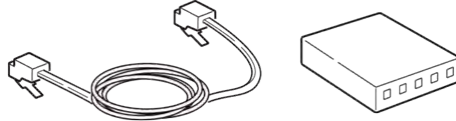

- 2 Power off this machine.
- 3 Plug one end of the LAN cable into the network interface connector (LAN1) of this machine.

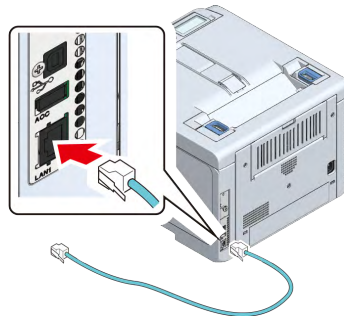

- 4 Plug the other end of LAN cable into the hub.

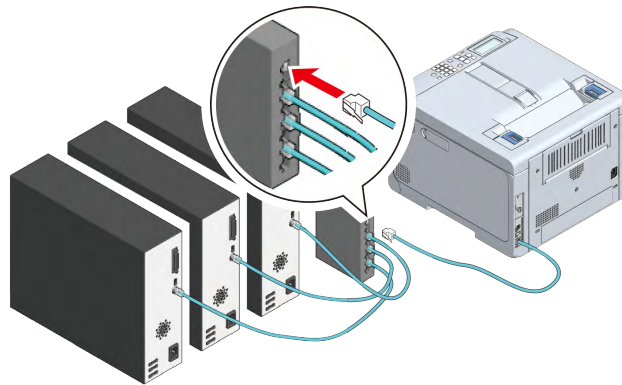

Then, set the network information like the IP address on this machine.

[Setting the IP address, etc.](#)(P.34)

Setting the IP address, etc.

Set values suitable for the current environment on the operator panel.
The following case is taken for example here.

(Example)

- IP address of this machine: 192.168.0.2
- Subnet mask: 255.255.255.0
- Gateway address: 192.168.0.1

When using a wireless LAN, see "[Connecting via a wireless LAN](#)(P.39)".

- 1 Power on this machine.
- 2 Press the scroll button ▼ on the operator panel several times to select [Admin Setup], and press «OK».
- 3 Input the admin password using the numeric keypad, and press «OK».
[Admin password](#)(P.114)
- 4 Check that [Network Setup] is selected, and press «OK».

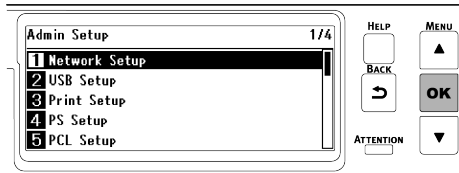

- 5 Press ▼ to select [Wired(LAN1) Setup], and press «OK».

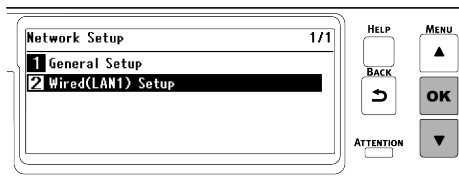

- 6 Press ▼ to select [IP Address Set], and press «OK».

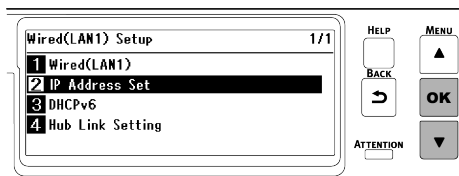

When you set the IP address manually, press ▼ to select [Manual] and press «OK».
Go to Step 7.

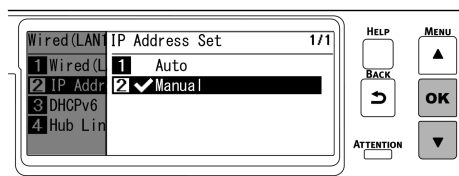

When you set the IP address automatically, check that [Auto] is selected and press «Back».
Go to Step 14.

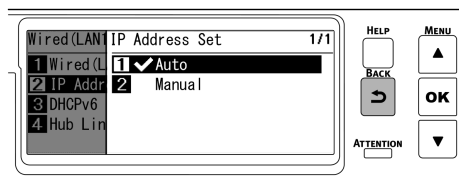

- 7 Press «BACK», then press ▼ to select [IPv4 Address] on the [Wired(LAN1) Setup] screen, and finally press «OK».

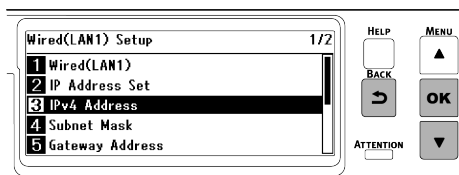

- 8** Use either the scroll buttons or the numeric keypad to input the first 3 digits of the IP address, and press «OK».

Input the next 3 digits in the same way. To move to the next box, press «OK».

Press «OK» after inputting all the digits.

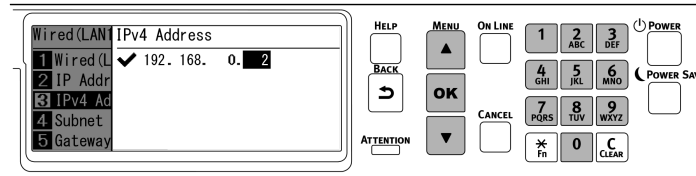

- 9** Check that the cursor has returned to the first 3 digit, and press «BACK».

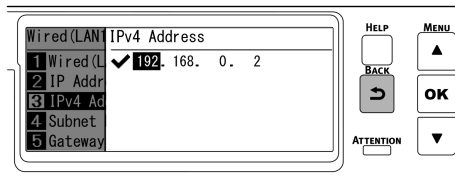

- 10** Press ▼ to select [Subnet Mask], and press «OK».

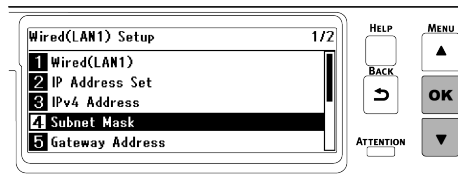

- 11** Input the subnet mask in the same way as the IP address. Press «OK» after inputting all the information, check that the cursor has returned to the first 3 digit, and press «BACK».

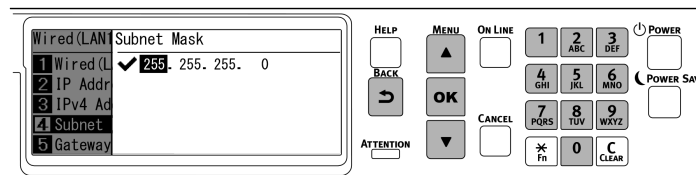

- 12** Press ▼ to select [Gateway Address], and press «OK».

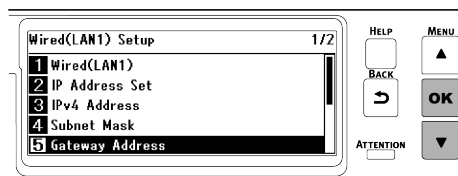

- 13** Input the gateway address in the same way as the IP address. Press «OK» after inputting all the information, check that the cursor has returned to the first 3 digit, and press «BACK».

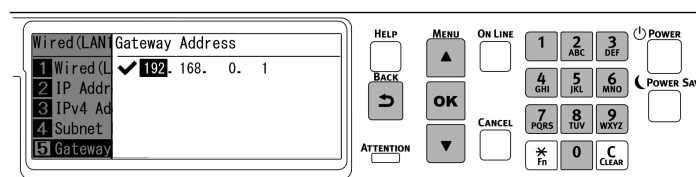

- 14 Press «ON LINE» to return to the standby screen.

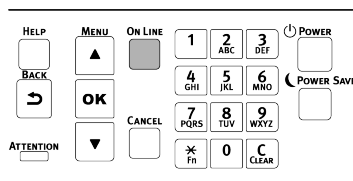

Checking the connection from a PC

Check the IP address of this machine, and access it from a PC by using the Web browser.

- 1 Press the scroll button ▼ on the operator panel several times to select [Configuration], and press «OK».
- 2 Press «5» on the [Configuration] screen.

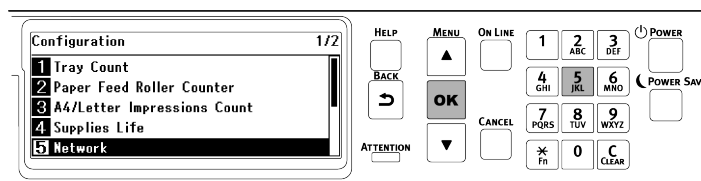

- 3 Check that [Network Setup] is selected, and press «OK».

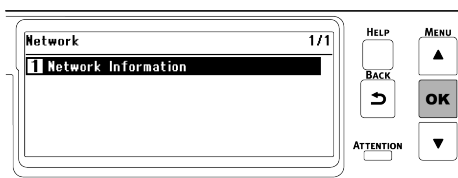

- 4 Press ▼ to select [Wired(LAN1) Information], and press «OK».

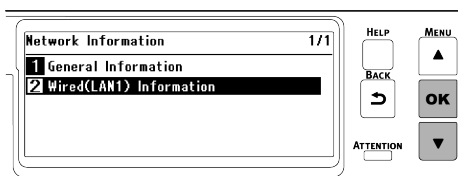

- 5 Press ▼ several times to select [IPv4 Address], and press «OK».

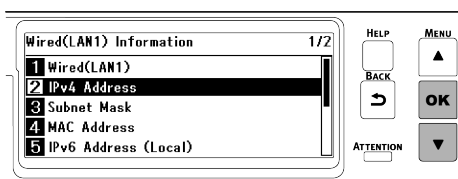

- 6 Take a note of the displayed IP address.
- 7 Start the Web browser in a PC.
- 8 Input "http:// (The IP address recorded in Step 6)", and press the «Enter» key.
Connection is successful when the web page of this machine is displayed.





- If the web page of this machine is not displayed, the network connection between the PC or other terminals and this machine has failed.
Check if [IP Address Set], [IPv4 Address], [Subnet Mask] and [Gateway Address] of this machine are set correctly.

Then, go to "[Installing software on a PC\(P.57\)](#)".

Connecting via a wireless LAN

Connect this machine and a PC via a wireless LAN to print.



- Wired LAN1 and wireless LAN can be used at the same time. If wired LAN1 and wireless LAN are connected to the same subnet, the communication may be unstable.
- Do not place an electric appliance (especially microwave oven or digital cordless telephone) that emits weak electronic waves near this machine.
- Wireless LAN connection may be inferior in communication speed compared to wired LAN connection or USB connection depending on the environment. When printing large data such as photos, we recommend you to print via a wired LAN or USB connection.

If detailed settings such as security and server are required, set them from the web page of this machine.

[Web page \(Managing this machine from a PC\) \(User's Manual\)](#)

Connection form

There are two types of connection forms between this machine and the PC via a wireless LAN. Select the connection form according to your environment, and prepare what is necessary as per the following table for the connection.



- Wireless LAN (Infrastructure) and wireless LAN (AP mode) cannot be used at the same time.
- Wired LAN1 and wireless LAN can be used at the same time.
- Since the communication may be unstable if wired LAN1 and wireless LAN are connected to the same subnet, please connect to a different subnet.

Type	Infrastructure	AP mode
Connection image		
Description	Connect this machine and the wireless terminal (PC, tablet, smartphone, etc.) via an access point.	Set this machine as a wireless access point, and connect it directly with the wireless terminal (PC, tablet, smartphone, etc.).
Required preparations	<ul style="list-style-type: none"> • Check the following information and take a note. <ul style="list-style-type: none"> Wireless settings of the printer Auto/Manual setting of the IP address For manual setting: <ul style="list-style-type: none"> IPv4 Address Subnet Mask Gateway Address Wireless LAN Access Point SSID Encryption Key • Check that your wireless LAN access point supports the following environment. <ul style="list-style-type: none"> Standard: IEEE 802.11 a/b/g/n Access mode: Infrastructure mode • Check that the wireless LAN access point supports WPS. • If WPS is not supported, check the SSID and encryption key with the User's Manual enclosed with your wireless access point. 	<ul style="list-style-type: none"> • Check that your wireless terminal supports the following environment. <ul style="list-style-type: none"> Standard: IEEE 802.11 b/g/n Security: WPA2-PSK(AES) • Check that your wireless terminal supports WPS-PBC (push button). • If you are not sure whether WPS-PBC is supported, connect manually after turning on the power of this machine.
Connection method	Connecting via an access point (Infrastructure)(P.40)	Connecting directly with this machine (AP mode)(P.51)



- SSID is also called the network name, ESSID or ESS-ID.
- Encryption key is also called the network key, security key, password, or pre-shared key (PSK).

Connecting via an access point (Infrastructure)



- Put this machine in an unobstructed view position near the wireless LAN access point. (The recommended distance is 30 m or less.)
- It may be difficult to connect if there is a metal, aluminum sash or reinforced concrete wall between this machine and the wireless LAN access point.
- When using 2.4GHz for a connection, use it within the range of 1 to 11ch. 12ch and 13ch may be available depending on the country or region.

1. Enabling the wireless LAN function

- 1 Power on this machine.
- 2 Press the scroll button ▼ on the operator panel several times to select [Admin Setup], and press «OK».
- 3 Input the admin password using the numeric keypad, and press «OK».
[Admin password\(P.114\)](#)
- 4 Check that [Network Setup] is selected, and press «OK».

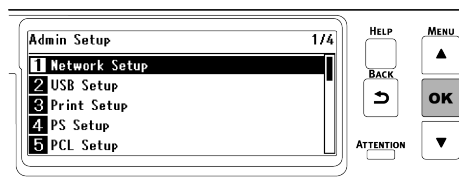

- 5 Check that [General Setup] is selected, and press «OK».

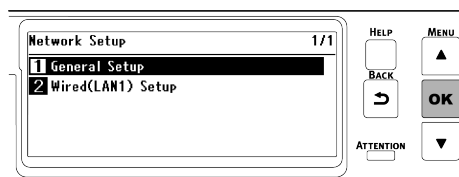

- 6 Check that [Extended Network] is selected, and press «OK».

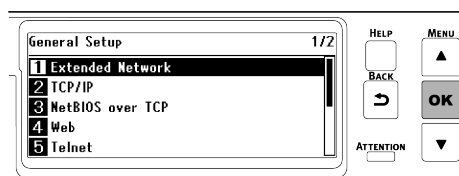

- 7 Press ▼ to select [Wireless], and press «OK».

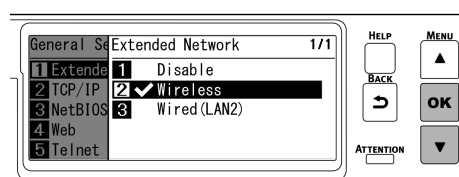

- 8 When [Are You Sure?] is displayed, check that [Yes] is selected, and press «OK».

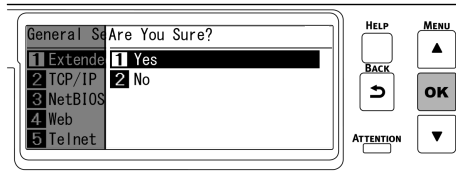

- 9 Wait until the standby screen appears as this machine restarts.
If [Not connected to wireless access point] is displayed, press «OK».
If "Set-up wireless?" is displayed, select [No], and press «OK».

2. Enabling infrastructure

- 1 Press the scroll button ▼ on the operator panel several times to select [Wireless(Infrastructure) Setting], and press «OK».

- 2 Input the admin password using the numeric keypad, and press «OK».

[Admin password](#)(P.114)



- "It is not possible to use the Wireless(AP Mode) at the same time." will be displayed for about 5 seconds.

- 3 Press ▲ to select [Enable], and press «OK».

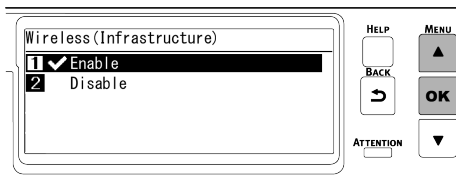

- After setting wireless(AP Mode) to [Disable], if a screen appears to ask you to check whether to enable wireless(Infrastructure), press «OK» to enable wireless (Infrastructure).

To set the IP address of this machine manually, go to "[3. Setting the IP address](#)".

To obtain an IP address automatically, go to "[4. Connecting with the wireless access point](#)".



- The factory default setting is [Auto].

3. Setting the IP address

If you want to set the machine's IP address to a fixed value, follow the procedure below.



- For [Auto], the machine's IP address may change dynamically.



- For [IPv4 Address], set a value which is not overlapped to any other networked machines.
- If you do not use the IPv6 address, set [DHCPv6] to [Disable].

(Example)

- IP address of this machine: 192.168.101.2
- Subnet mask: 255.255.255.0
- Gateway address: 192.168.101.1

When using a wired LAN, see "[Setting the IP address, etc.\(P.34\)](#)".

1 Press the scroll button ▼ on the operator panel several times to select [Wireless(Infrastructure) Setting], and press «OK».

2 Input the admin password using the numeric keypad, and press «OK».

 [Admin password\(P.114\)](#)



- "It is not possible to use the wireless(AP Mode) at the same time." will be displayed for about 5 seconds.

3 Press ▲ to select [Enable], and press «OK».

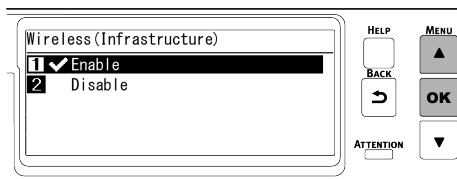

4 Press ▼ to select [Network Setting], and press «OK».

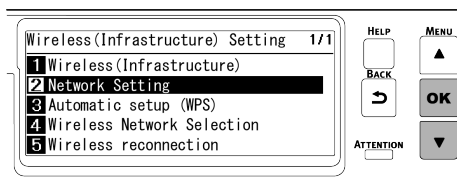

5 Check that [IP Address Set] is selected, and press «OK».

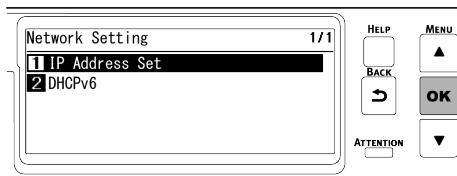

6 Press ▼ to select [Manual], and press «OK».

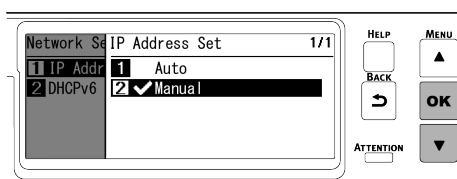

7 Press «BACK», then press ▼ to select [IPv4 Address] on the [Network Setting] screen, and finally press «OK».

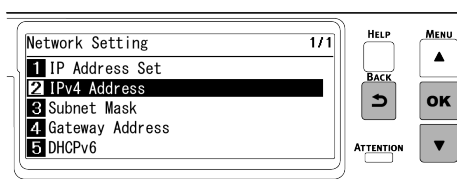

- 8** Use either the scroll buttons or the numeric keypad to input the first 3 digits of the IP address, and press «OK». Likewise, input the next 3 digits, and press «OK». Press «OK» after inputting all the digits.

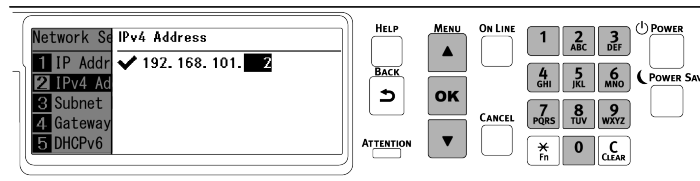

- 9** Press ▼ to select [Subnet Mask], and press «OK».

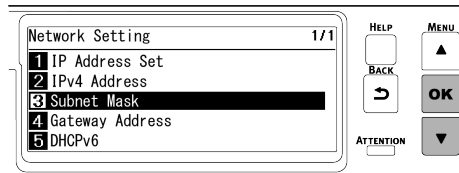

- 10** Input the subnet mask in the same way as the IP address. Press «OK» after inputting all the digits.

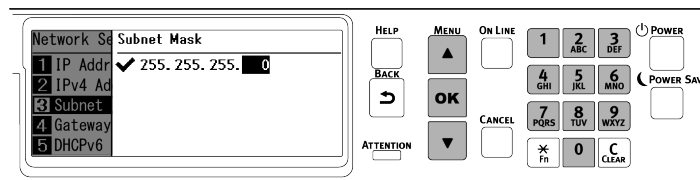

- 11** Press ▼ to select [Gateway Address], and press «OK».

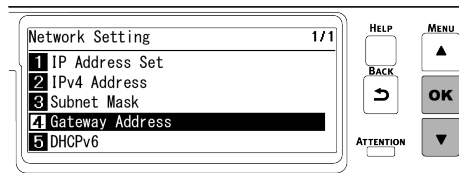

- 12** Input the gateway address in the same way as the IP address. Press «OK» after inputting all the digits.

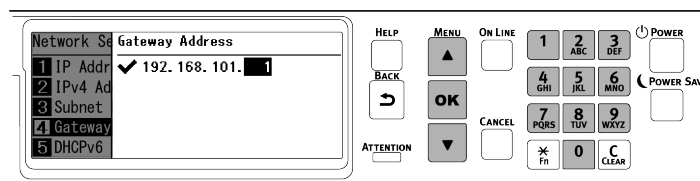

- 13** Press «ON LINE» to return to the standby screen.

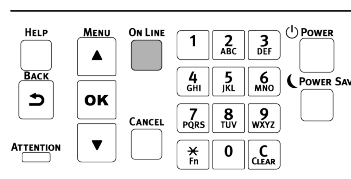

4. Connecting with the wireless access point

There are three ways as follows. Usually, it is connected with the simplest WPS.

- Connecting with WPS
- Connecting by selecting a wireless LAN access point from the operator panel
- Connecting by setting manually from the operator panel



- When you connect with wireless LAN by WPA/WPA2-EAP, see "Setting IEEE802.1X (Wireless LAN) (User's Manual)".

Connecting with WPS

If the wireless LAN access point supports WPS, you can easily connect to the wireless LAN using the push button for easy setup (WPS button).

- 1 Check the position of push button for easy setup (WPS button) and the time for which the button is pressed in the User's Manual enclosed with the wireless LAN access point.
- 2 Check that the wireless LAN access point is activated and operating properly.
- 3 Press the scroll button ▲ on the operator panel several times to select [Wireless(Infrastructure) Setting], and press «OK».
- 4 Input the admin password using the numeric keypad, and press «OK».

[Admin password\(P.114\)](#)



- "It is not possible to use the wireless(AP Mode) at the same time." will be displayed for about 5 seconds.

- 5 Press ▲ to select [Enable], and press «OK».

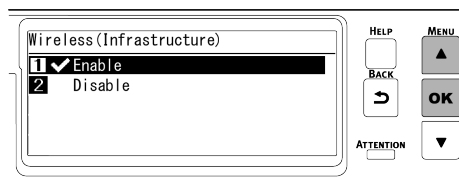

- 6 Press ▼ several times to select [Automatic setup (WPS)], and press «OK».

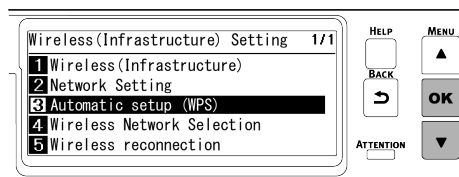

- 7 Check that [WPS-PBC] is selected, and press «OK».

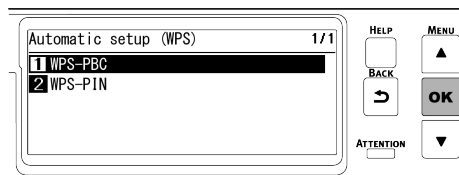

- 8 When "Implementing this method? Pushbutton method" is displayed, check that [Yes] is selected, and press «OK».

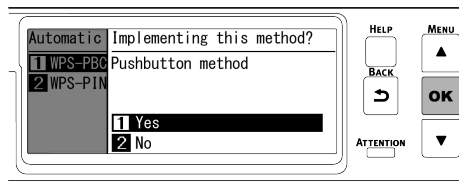

"Running pushbutton method" is displayed, and this machine will start to search for a wireless LAN access point.

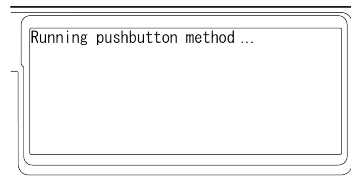

- 9 Press and hold the push button of wireless LAN access point for the period of time confirmed in Step 1 or for a few seconds.



- "Running pushbutton method" is displayed for about 2 minutes. Press the push button of wireless LAN access point while it is displayed.
- While "Running pushbutton method" is displayed, the operator panel of this machine is disabled.

- 10 When "WPS connection successful" is displayed, the connection to the wireless LAN access point is completed.

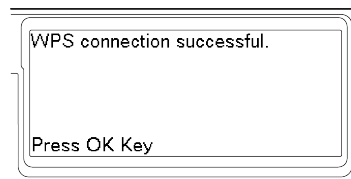

Go to "6. Checking the connection from a PC".



- When "Not connected to wireless access point" or "Connection failed." is displayed, repeat the procedure from Step 1, or try "[Connecting by selecting a wireless LAN access point from the operator panel](#)".

Connecting by selecting a wireless LAN access point from the operator panel

When the wireless LAN access point does not support WPS or when WPS connection does not function well, connect by specifying the wireless access point to be used from the list of wireless access points detected by this machine. In this case, it is required to input the SSID and encryption key.

- 1 Check and take a note of the SSID and encryption key on the side of the wireless LAN access point or in the User's Manual enclosed with the access point.
 - WPA-EAP and WPA2-EAP cannot be set from the operator panel. Set them from the web page of this machine.
 - 🔗 [Opening the web page \(User's Manual\)](#)
- 2 Check that the wireless LAN access point is activated and operating properly.
- 3 Press the scroll button ▼ on the operator panel several times to select [Wireless(Infrastructure) Setting], and press «OK».

4 Input the admin password using the numeric keypad, and press «OK».

 [Admin password\(P.114\)](#)



- "It is not possible to use the wireless(AP Mode) at the same time." will be displayed for about 5 seconds.

5 Press ▲ to select [Enable], and press «OK».

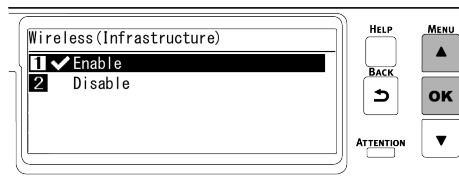

6 Press ▼ several times to select [Wireless Network Selection], and press «OK».

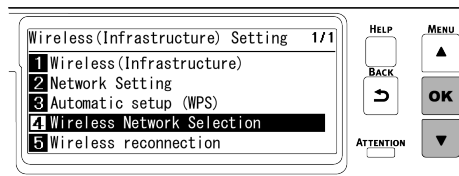

This machine starts searching for wireless LAN access points.

7 A list of SSID of connectible wireless LAN access points is displayed. Press ▲ or ▼ to select the SSID of the wireless LAN access point recorded in Step 1, and press «OK».

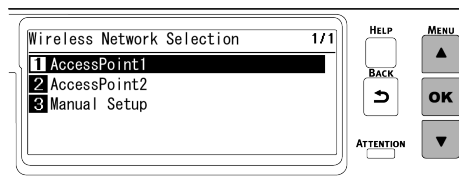

If no wireless LAN access point is found, only [Manual Setup] is displayed. In that case, make settings by following "[Connecting by setting manually from the operator panel](#)".

8 When the encryption key entry screen suitable for the encryption method of the selected wireless LAN access point is displayed, input the encryption key recorded in Step 1, and press «OK».



- The encryption key varies with the wireless LAN access point and security method.
 - When "WPA Pre-shared key" is displayed
 - Encryption method: WPA/WPA2-PSK or WPA2-PSK
 - Encryption key: Please input the WPA pre-shared key.
 - When "Please set in Web" is displayed
 - Encryption method: WPA/WPA2-EAP or WPA2-EAP
 - * Make settings from the web page of this machine.
 - When "WEP key" is displayed
 - Encryption method: WEP
 - Encryption key: Please input the WEP key.
 - In other cases
 - Encryption method: Disable
 - No need to input the encryption key.

- 9 "Implementing this method?" is displayed, and the SSID selected in Step 7 from the confirmation screen and the encryption method input in Step 8 are displayed as the security method. If the SSID is the same as the one recorded in Step 1, press «OK».

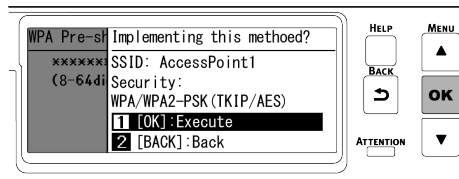

- 10 When "Connection successful." is displayed, the connection to the wireless LAN access point is completed.

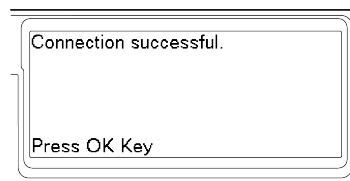

Go to "6. Checking the connection from a PC".



- When "Not connected to wireless access point" is displayed, repeat the procedure from Step 4, or try "Connecting by setting manually from the operator panel".

Connecting by setting manually from the operator panel

Set the wireless LAN access point information (SSID, encryption method, encrypted key) manually, and connect to the wireless LAN.

- 1 Check and take a note of the SSID and encryption key on the wireless LAN access point or in the enclosed User's Manual.



- WPA-EAP and WPA2-EAP cannot be set from the operator panel. Set them from the web page of this machine.

 [Opening the web page \(User's Manual\)](#)



- SSID is also called the network name, ESSID or ESS-ID.
- Encryption key is also called the network key, security key, password, or pre-shared key (PSK).

- 2 Check that the wireless LAN access point is activated and operating properly.

- 3 Press the scroll button ▼ on the operator panel several times to select [Wireless(Infrastructure) Setting], and press «OK».

- 4 Input the admin password using the numeric keypad, and press «OK».

 [Admin password\(P.114\)](#)



- "It is not possible to use the wireless(AP Mode) at the same time." will be displayed for about 5 seconds.

- 5 Press ▼ several times to select [Wireless Network Selection], and press «OK».

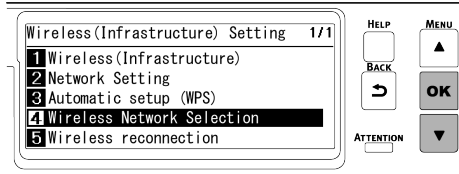

Start searching for wireless LAN access points. Please wait.

- 6 A list of SSID of connectible wireless LAN access points is displayed. Press ▼ several times to select [Manual Setup] at the end of the list, and press «OK».

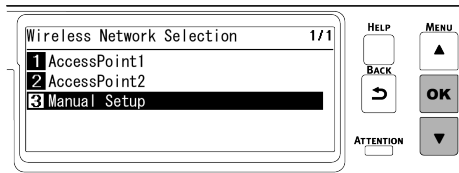

- 7 Check that [SSID] is selected, and press «OK».

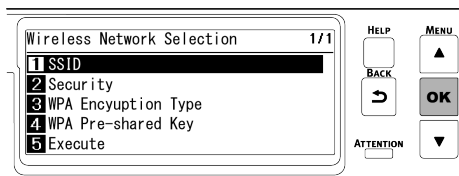

- 8 Input the SSID recorded in Step 1, and press «OK».

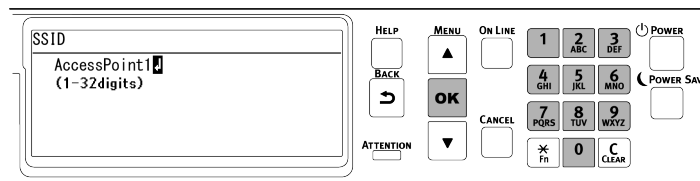

- 9 Press ▼ to select [Security], and press «OK».

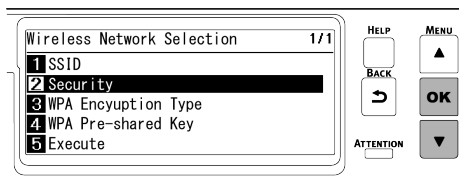

- 10 Select the encryption method recorded in Step 1, and press «OK».

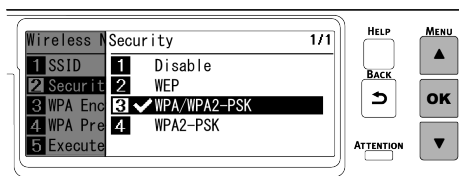

- 11 Press ▼ to select [WPA Pre-shared Key], and press «OK».

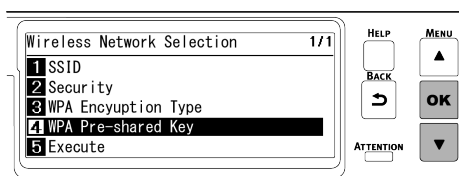

- 12 Input the encryption key recorded in Step 1, and press «OK».

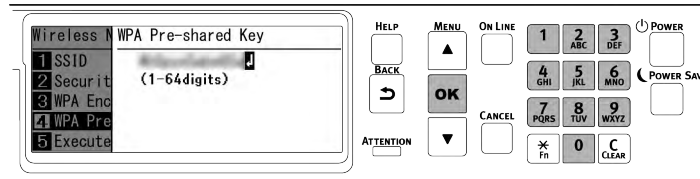

- The encryption key varies with the wireless LAN access point and security method.

- 13 Press ▼ to select [Execute], and press «OK».

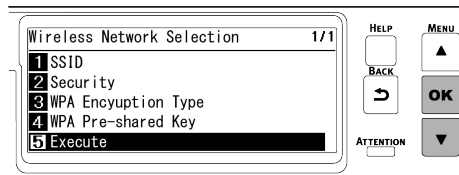

- 14 "Implementing this method?" is displayed, and the SSID selected in Step 8 from the confirmation screen and the encryption method input in Step 10 are displayed as the security method. If the SSID is the same as the one recorded in Step 1, press «OK».

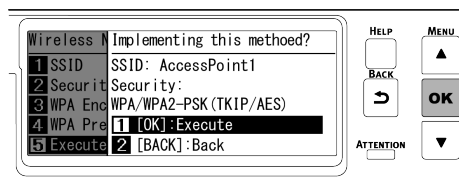

- 15 When "Connection successful." is displayed, the connection to the wireless LAN access point is completed.

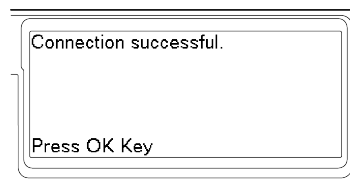

Go to "6. Checking the connection from a PC".



- When "Not connected to wireless access point" is displayed, repeat the procedure from Step 4.
- If you cannot connect, see "Troubleshooting for wireless LAN connection (User's Manual)".

5. Choosing a valid default gateway

By default, [Enabling Default Gateway] is set to [Wired(LAN1)]. This machine can use a wired LAN and wireless LAN at the same time, but only either of them can be used to connect a terminal outside the segment (a different subnet).

When a wireless LAN (infrastructure) is used to communicate across segments, follow the following procedure to change into [Wireless(Infrastructure)].

- 1 Check that "Ready To Print" appears on the display.



- If the machine is in the power save mode, press «POWER SAVE» to restore.

- 2 Press the scroll button ▼ on the operator panel several times to select [Admin Setup], and press «OK».
- 3 Input the admin password using the numeric keypad, and press «OK».
[Admin password](#)(P.114)
- 4 Check that [Network Setup] is selected, and press «OK».

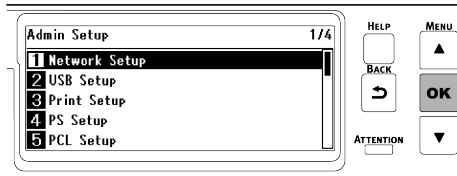

- 5 Check that [General Setup] is selected, and press «OK».

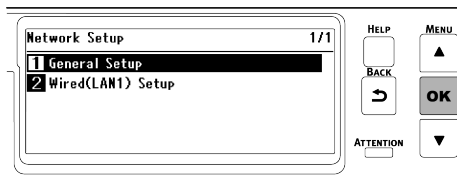

- 6 Press ▼ to select [Enabling Default Gateway], and press «OK».

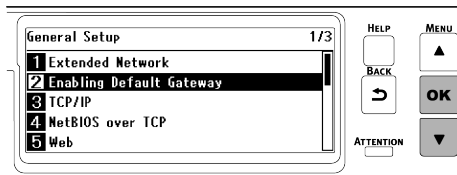

- 7 Press ▼ to select [Wireless(Infrastructure)], and press «OK».

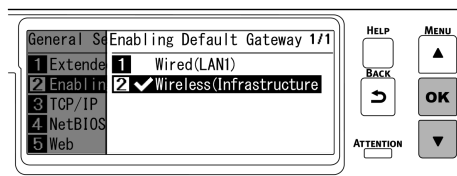

- 8 Press «ON LINE» to return to the standby screen.

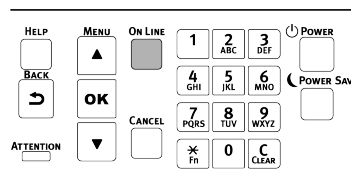

6. Checking the connection from a PC

Check the IP address of the device, and access it from a PC by using the Web browser.

- 1 Press the scroll button ▼ on the operator panel several times to select [Configuration], and press «OK».

- 2 Press «5» on the [Configuration] screen.

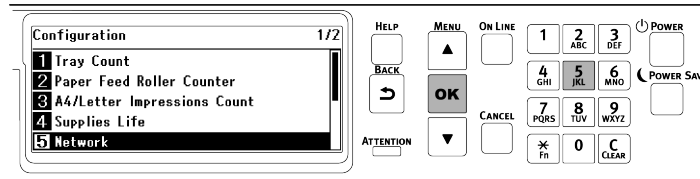

- 3 Press ▼ to select [Wireless(Infrastructure) Information], and press «OK».

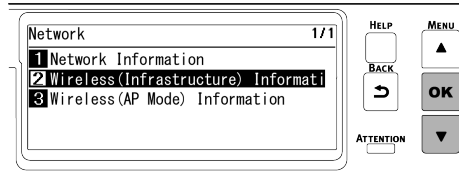

- 4 Press ▼ several times to select [IPv4 Address], and press «OK».

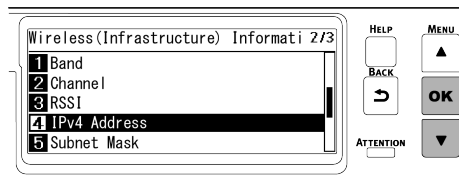

- 5 Take a note of the displayed IP address.

- 6 Start the web browser in a PC.

- 7 Input "http:// (The IP address recorded in Step 5)", and press the «Enter» key.

Connection is successful when the web page of this machine is displayed.



- If the web page of this machine is not displayed, the network connection between the PC or other terminals and this machine has failed.
Check that [IP Address Set], [IPv4 Address], [Subnet Mask], [Gateway Address] and [Enabling Default Gateway] have been set correctly for this machine.

Then, go to "[Installing software on a PC\(P.57\)](#)".

When using a mobile device, go to "[Printing from a mobile device \(User's Manual\)](#)".

Connecting directly with this machine (AP mode)



- It may be difficult to connect if there is a metal, aluminum sash or reinforced concrete wall between this machine and the wireless terminal.
- Up to 4 terminals can be connected to this machine wirelessly (AP mode). You cannot connect 5 or more terminals.

1. Enabling the wireless LAN function

- 1 Power on this machine.

- 2 Press the scroll button ▼ on the operator panel several times to select [Admin Setup], and press «OK».
- 3 Input the admin password using the numeric keypad, and press «OK».
[Admin password](#)(P.114)
- 4 Check that [Network Setup] is selected, and press «OK».

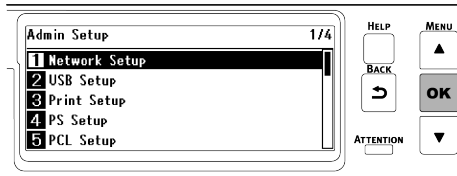

- 5 Check that [General Setup] is selected, and press «OK».

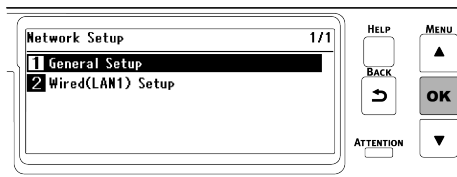

- 6 Check that [Extended Network] is selected, and press «OK».

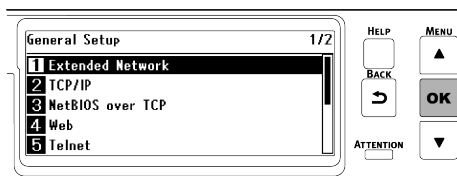

- 7 Press ▼ to select [Wireless], and press «OK».

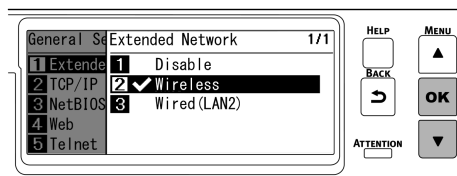

- 8 When [Are You Sure?] is displayed, check that [Yes] is selected, and press «OK».

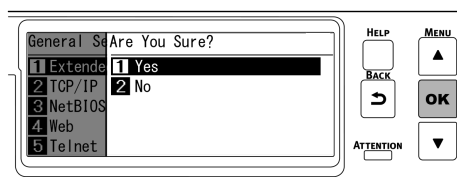

- 9 Wait until the standby screen appears as this machine restarts.

2. Enabling the AP mode

- 1 Press the scroll button ▼ on the operator panel several times to select [Wireless(AP Mode) Setting], and press «OK».
- 2 Input the admin password using the numeric keypad, and press «OK».
[Admin password](#)(P.114)

- 3 Check that [Wireless(AP Mode)] is selected, and press «OK».

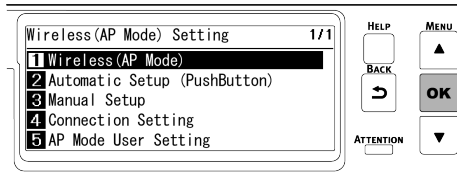

- "Cannot be used simultaneously with wireless(infrastructure)." will be displayed for about 5 seconds.

- 4 Press ▲ to select [Enable], and press «OK».

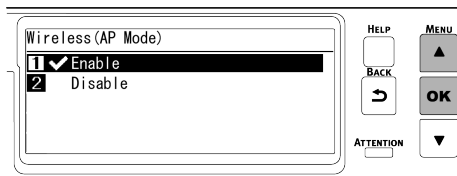

- After setting Wireless(Infrastructure) to [Disable], if a screen appears to ask you to check whether to enable wireless (AP mode), press «OK» to enable wireless (AP mode).

- 5 Press «ON LINE» to return to the standby screen.

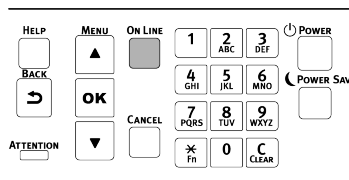

3. Connecting with a device

There are two ways as follows.

- Connecting automatically(Push button)
- Connecting manually

Connecting automatically (Push button)

If the wireless terminal supports WPS-PBC (push button), you can connect it to this machine using the WPS button.

- 1 Check the position of the WPS button in the User's Manual enclosed with the wireless terminal.
- 2 Press the scroll button ▼ on the operator panel several times to select [Wireless(AP Mode) Setting], and press «OK».
- 3 Input the admin password using the numeric keypad, and press «OK».

[Admin password\(P.114\)](#)



- "Cannot be used simultaneously with wireless(infrastructure)." will be displayed for about 5 seconds.

- 4 Press ▲ to select [Enable], and press «OK».

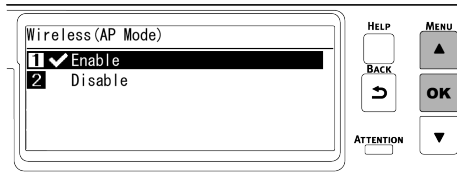

- 5 Press ▼ to select [Automatic Setup (PushButton)] , and press «OK».

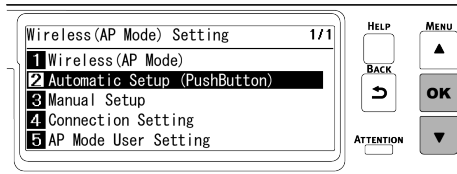

- 6 When "Implementing this method? Pushbutton method" is displayed, check that [Yes] is selected, and press «OK».

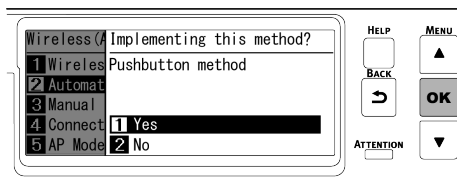

"Running pushbutton method" is displayed, and this machine will start to search for a wireless LAN access point.

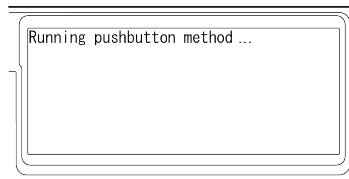

- 7 Start WPS-PBC (push button) on the wireless terminal.



- "Running pushbutton method" is displayed for about 2 minutes. Start the push button on the wireless terminal while it is displayed.
- While "Running pushbutton method" is displayed, the operator panel of this machine is disabled.

- 8 When "Connection successful." is displayed, the connection is completed.

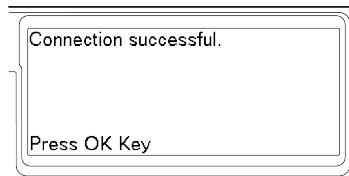

- If the connection fails, follow the procedure in "[Connecting manually](#)" to connect again. Then, go to "[Installing software on a PC\(P.57\)](#)". When using a mobile device, go to "[Printing from a mobile device \(User's Manual\)](#)".

Connecting manually

If the wireless terminal does not support WPS-PBC (push button), input the SSID and password of this machine in the wireless terminal to connect.

1 Press the scroll button ▼ on the operator panel several times to select [Wireless(AP Mode) Setting], and press «OK».

2 Input the admin password using the numeric keypad, and press «OK».

 [Admin password](#)(P.114)



- "Cannot be used simultaneously with wireless(infrastructure)." will be displayed for about 5 seconds.

3 Press ▲ to select [Enable], and press «OK».

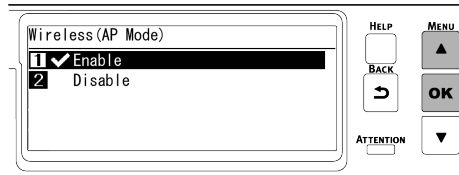

4 Press ▼ several times to select [Manual Setup], and press «OK».

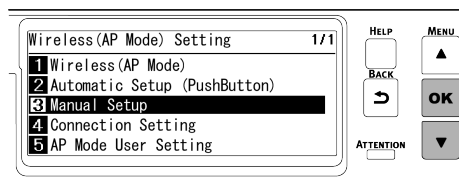

5 Check that [SSID] and [Password] of this machine are displayed.



- The screens shown here are examples, and they may differ from the actual display.

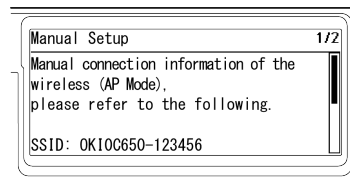

6 Input [SSID] and [Password] of this machine confirmed in Step 5 in the wireless terminal to connect.



- If the wireless terminal is set to obtain the IP address automatically, you can communicate by connecting to this machine in the AP mode and allocating the IPv4 address automatically to the mobile terminal.
- The factory default IP address is [192.168.110.100].
- If you cannot connect, see "Troubleshooting for wireless LAN connection (User's Manual)".

Then, go to "[Installing software on a PC](#)(P.57)".

When using a mobile device, go to "Printing from a mobile device (User's Manual)".

Connecting via USB

Connect this machine and a PC with a USB cable to print.

1 Prepare a USB 2.0 cable.



- Not compatible with USB 3.0.
- The connector shape on the machine side is of type B.



- To connect in the USB 2.0 hi-speed mode, use a USB cable compliant with USB 2.0 hi-speed specifications.

2 Power off this machine.

3 Plug one end of the USB cable into the USB interface connector of this machine.



- Do not insert the USB cable into the network interface connector. Doing so may cause a malfunction.

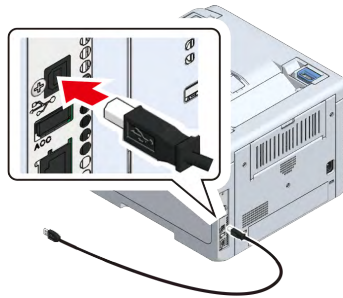

4 Plug the other end of the USB cable into the USB interface connector of the PC.

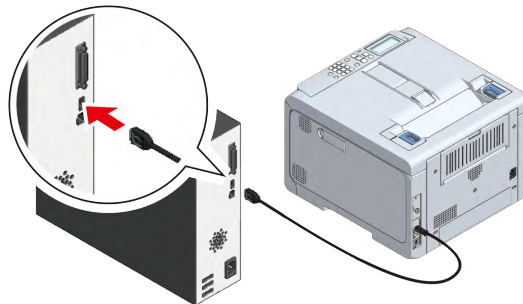

Proceed to "[Installing software on a PC\(P.57\)](#)".

Installing software on a PC

If your PC comes with a DVD drive, install the printer driver and other software on the PC from the provided DVD.

If your PC does not come with a DVD drive, or if you want to update the printer driver or any other software, download and install it from the website.

Operating environment

- Windows 10
- Windows 8.1
- Windows 8
- Windows 7
- Windows Server 2019
- Windows Server 2016
- Windows Server 2012 R2
- Windows Server 2012
- Windows Server 2008 R2
- Windows Server 2008
- macOS 10.15 - 10.12, OS X 10.11



- The screen display may differ from the description depending on the version of Windows and macOS or the specific printer driver.

Types of printer driver

There are two types of printer driver, the PCL printer driver and the PS printer driver. For normal printing, use the PCL printer driver. The PS printer driver is suitable for printing documents containing the ESP data or the PostScript font.

[Screens and functions of the printer driver\(P.103\)](#)



- Only the PS printer driver is applicable to macOS.

For Windows

- 1 Check that this machine and the PC are connected, and that the power supply is on.
- 2 Insert the provided DVD to the PC.



- To install the driver from the provided DVD, it is necessary to install and enable .NET Framework 3.5 or above.

3 When the [DVD drive] screen is displayed, click [Launch Setup.exe].

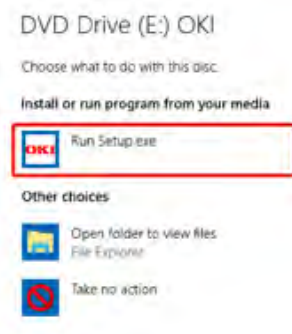

- If the [User Account Control] screen is displayed, click [Yes].
- If the [DVD drive] screen is not displayed, open DVD from the Explorer.

4 Choose a language from the pull-down menu of language selection in the [Welcome] screen.

5 Read the software license agreement, and click [Accept].

6 Read the environmental advice, and click [Go].

7 Click either [Network Connection] or [USB Connection] depending on the connection method between the PC and this machine.

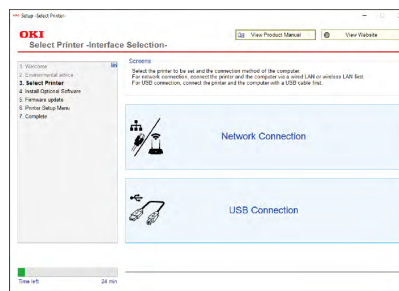

If [Windows Security Alert] screen is displayed, click [Allow Access].

8 Select the model name of this machine, and click [Go].



- If the printer is not displayed with a network connection, input the IP address assigned to the printer by selecting [Search Range], and click [Search Again].

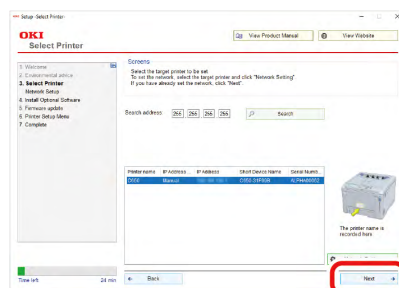

9 Click [Recommended Install].

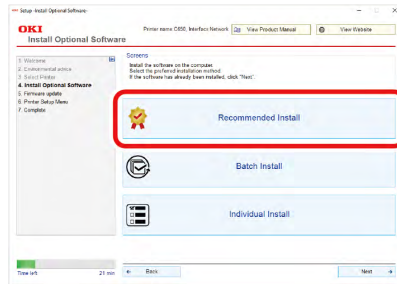

Check the software, and click [Start].

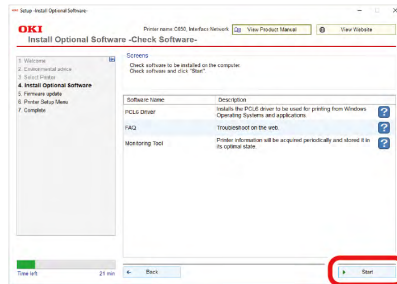

Installation will begin.



- The following software will be installed.
 - PCL6 printer driver (including Network Extension, Color Swatch Utility)
 - FAQs
 - Monitoring Tool
- Other software is installed from either [Batch Install] or [Individual Install].

10 Check that the software installation is complete.

11 Click [Exit].

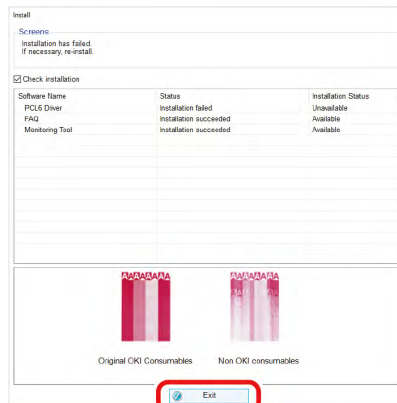

The [Firmware Update] screen is displayed.

- 12** If you do not need to update, click [Go].
Click [Confirm] if you do not know or an update is required.

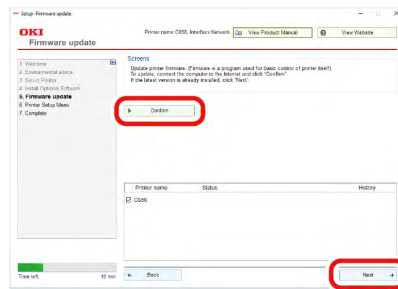

If the following screen appears, click [Yes].

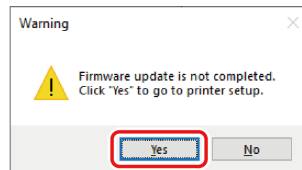

After the update is completed, click [Go].

- 13** Click [Go].

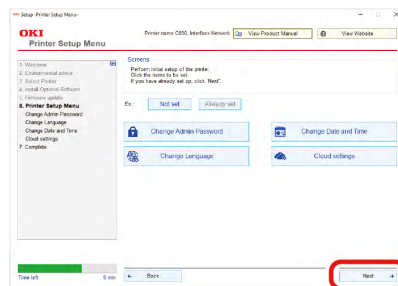

If the following screen appears, click [Yes].

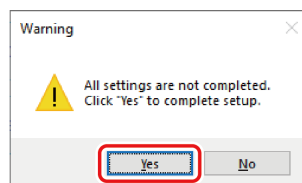

- 14** Click [Exit].

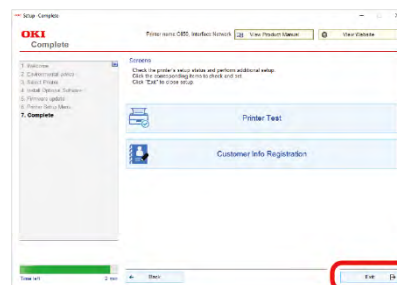

Now installation is completed.

If you install options like the expansion tray unit, change the settings of printer driver.

[Setting the printer driver\(P.62\)](#)

When the Monitoring Tool is displayed, register the installed printer.

[Monitoring Tool \(Windows\) \(User's Manual\)](#)

For macOS

- 1 Check that this machine and the PC are connected, and that the power supply is on.
- 2 Insert the included DVD to the PC.
- 3 Double-click on the [OKI] icon on the desktop.
- 4 Double-click on [Drivers] - [PS] - [Installer for OSX].
- 5 Finish the installation by following the on-screen instructions.
- 6 Select [System Preferences] from the Apple menu.
- 7 Click [Printers and Scanners].
- 8 Click [+], and select [Add Printer or Scanner] when the menu appears.

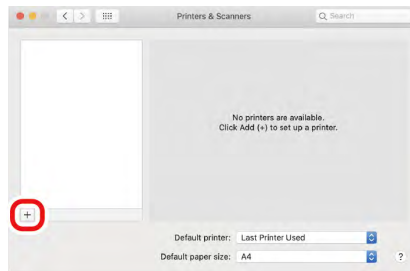

- If you cannot click [+], click the key mark.

- 9 Click [Default].
- 10 Select this machine, and select [OKI C650 PS] from [Drivers].

Connection Method	Listed name	Type
Network	OKI-C650 (Last 6 digits of the MAC address)	Bonjour
USB	OKI DATA CORP C650	USB



- The MAC address can be checked by pressing the scroll buttons on the operator panel to print the network information from [Print Information] - [Network].
- To change the name, input a new name to be used in [Name].

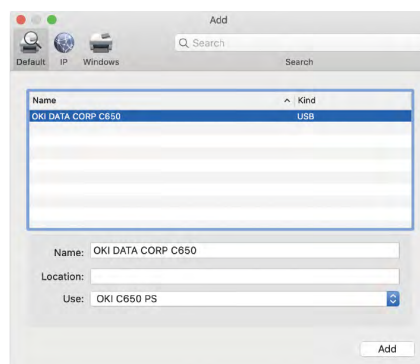

- 11 Click [Add].



- If the option confirmation screen appears, click [OK].

- 12 Make sure that this machine is added to the list of [Printers] and that "OKI C650 PS" is displayed in [Type].

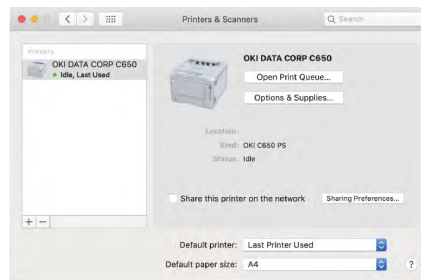

- If "OKI C650 PS" is not displayed in [Type] properly, click [-] to delete this machine from [Print], and then repeat Steps 8 - 12.

- 13 Click [Open the Print Queue].

- 14 Select [Print Test Page] from the [Print] menu.

Installation is completed when the test page is printed.

If you install options like the expansion tray unit, change the settings of printer driver.

[Setting the printer driver\(P.62\)](#)

Setting the printer driver

If an expansion tray unit has been installed, change the printer driver settings with the following procedure after installing the printer driver.

[Installing software on a PC\(P.57\)](#)



- To follow this procedure, it is necessary to log into the computer with administrator privileges.

For Windows PCL printer driver

- 1 Open the "Devices and Printers".

[How to open the printer folder\(P.112\)](#)

- 2 Right-click on the icon of [OKI C650 PCL], and select [Printer Properties].

- 3 Select the [Device Options] tab.

4 For a network connection, click [Get Printer Settings].

For a USB connection, input the number of trays minus the MP tray in [Installed Paper Trays].

For example, if three expansion tray units are mounted, the usable trays are trays 1/2/3/4, so input "4".

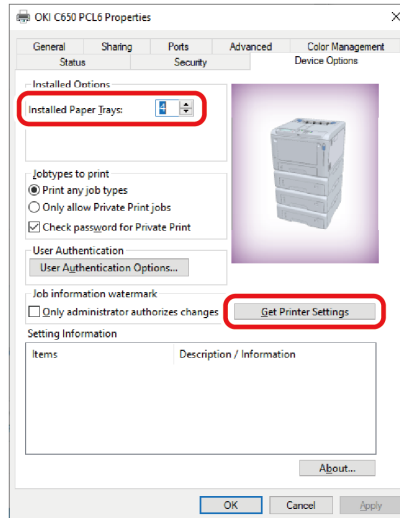

5 Click [OK].

For Windows PS printer driver

1 Open the "Devices and Printers".

[How to open the printer folder\(P.112\)](#)

2 Right-click on the icon of [OKI C650 PS], and select [Printer Properties].

3 Select the [Device Settings] tab.

4 For a network connection, select [Get installed options automatically] in [Installable Options], and click [Setup].

For a USB connection, select the corresponding value in [Available Trays] of [Installable Options].

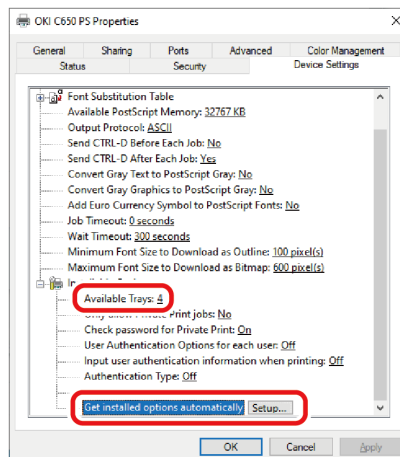

5 Click [OK].

For macOS



- Depending on the timing when the printer is added, the information for the expansion tray unit may have been set.

- 1 Select [System Preferences] from the Apple menu.
- 2 Click [Print & Scan].
- 3 Select this machine, and click [Options and Supplies].
- 4 Select the [Options] tab.
- 5 Select the total number of trays from [Available Trays], and click [OK].

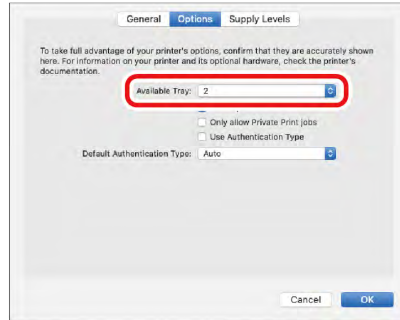

3 Basic operations

Parts identification	66
Turning the power on/off	69
Loading paper	70
Setting the output bin	82
Checking the configuration.....	84
How to use levers L1 and L2.....	86

Parts identification

This section explains the name and functions of each part of the main unit.

Front

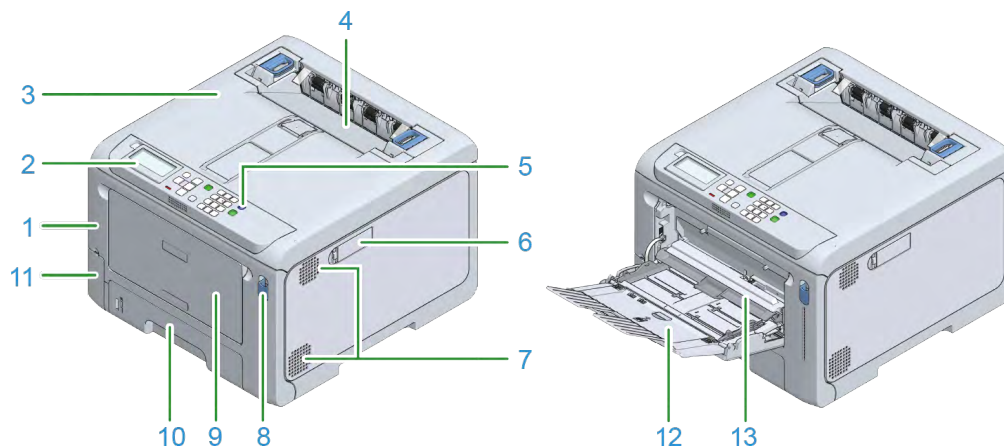

No.	Name	Function
1	Front cover	This is the cover on the front side of the main unit. You can open the front cover by pulling its lever towards yourself.
2	Operator panel	This is the panel used to operate the main unit. It comes with a display, functional buttons, a numeric keypad, a Fn key, an attention lamp, etc. Parts identification of the operator panel(P.89)
3	Output tray (Top cover)	This is the output tray on the top of the main unit. You can open it by pulling up the open lever inside after opening the front cover.
4	Fuser unit	This unit fixes the toner to the paper.
5	Power switch	Turns on/off the power of the main unit. Lights blue when the power is turned on, and lights off when the power is turned off.
6	Wireless LAN module cover	A cover for the housing of the wireless LAN module.
7	Air vents	Allows air to enter and exit from the inside of the main unit. Be careful not to block the air vents.
8	Front cover lever	This is a blue lever to unlock to open the front cover.
9	Multi Purpose Tray (MP tray)	In addition to paper of various sizes, you can also print on envelopes.
10	Tray 1	Load the paper to print on.
11	Waste toner box cover	This is the storage port of the box that holds the waste toner.
12	Paper supporter	Load the paper in the MP tray.
13	Paper placement cover	Holds the paper loaded in the MP tray.

Inside the main unit

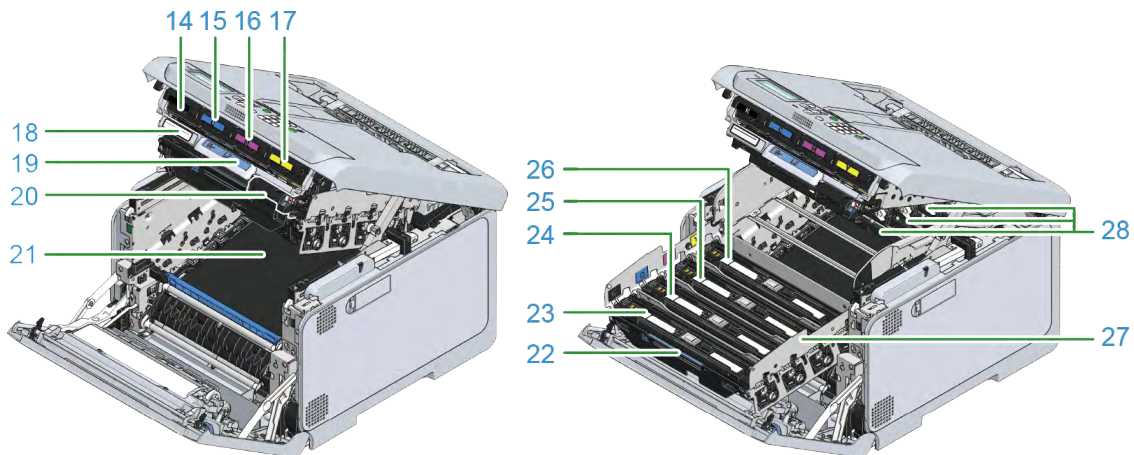

No.	Name	Function
14	Toner cartridge black (K: Black)	The toner cartridge contains toner (powder ink) for printing. The toner cartridge is a consumable.
15	Toner cartridge (C: Cyan)	
16	Toner cartridge (M: Magenta)	
17	Toner cartridge (Y: Yellow)	
18	Serial number	The machine-specific number.
19	Lever L2	The lever used to lift up the cover of the output tray.
20	Lever L1	The lever uses to replace the image drum.
21	Belt unit	The unit to convey the paper.
22	Handle L3	The handle used to pull out the image drum basket.
23	Image drum (K: Black)	The image drum is a unit to create an image on the paper by using toner. The image drum is a consumable.
24	Image drum (C: Cyan)	
25	Image drum (M: Magenta)	
26	Image drum (Y: Yellow)	
27	Image drum basket	Holds the image drum.
28	LED head (x 4)	Writes an image onto the image drum using light.

Back

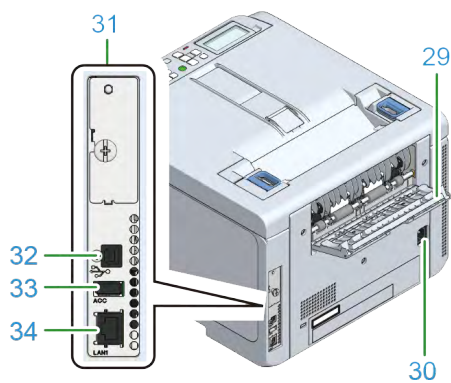

No.	Name	Function
29	Rear output tray	This is the paper exit when the paper is output with the print side facing up.
30	Power connector	This is where the included power cord is plugged in.
31	Interface unit	There is a connector to connect to a PC.
32	USB interface connector	This is where the USB cable is plugged in when the computer and the main unit is connected with a USB cable.
33	Accessory connector	This is a port to which the USB memory is connected.
34	Network interface connector (LAN1)	This is where the LAN cable is plugged in when the computer and the main unit is connected via a network.

Turning the power on/off

Turning the power on

- 1 Press and hold the power switch for approx. one second.

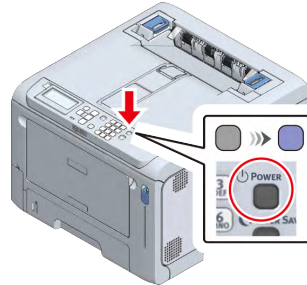

When the power is on, the LED lamp of the power switch will light on.
When this machine gets ready, "Ready To Print" will appear on the display.

Turning the power off

- 1 Press and hold the power switch for approx. 1 second.

"Shutting down. Please wait. The power will turn off automatically" will appear on the display, and the LED lamp of the power switch will flash at intervals of approx. 1 second.

Wait a moment, and this machine will be powered off automatically, and the LED lamp of the power switch will turn off.



- If you press and hold the power switch for approx. 1 second while this machine is in the power save mode, the power will turn off without displaying anything.
- Please wait. This may take about 5 minutes to turn off the power.
- Press and hold the power switch for more than 5 seconds to turn off the power by force. Use only if a problem has occurred. For troubles with this machine, refer to "Troubleshooting for the machine (User's Manual)".

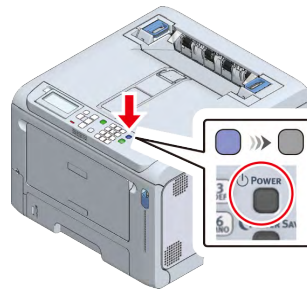

Loading paper

This section explains the types of paper applicable to this machine, paper precautions and paper storage methods.

Procedure for loading paper

1. Check the applicable paper.

- [Applicable paper\(P.70\)](#)
- [Inapplicable paper\(P.72\)](#)

2. Load the paper in the tray.

- [Paper applicable to each tray\(P.74\)](#)
- [Loading paper in Tray 1\(P.74\)](#)
- [Loading paper in Tray 2/3/4 \(Optional\)\(P.76\)](#)
- [Loading paper in the MP tray\(P.78\)](#)

3. Set the paper information (media size, media type, media weight) on the operator panel.

- [Setting paper information on the operator panel\(P.79\)](#)

Applicable paper

In order to maintain high-quality printing, it is necessary to use paper that fulfills the quality, weight and surface finish conditions. Please use electrophotographic paper.

If you are printing on non-recommended paper, thoroughly test the print quality and paper traction beforehand and check that there are no problems before use.

For precautions for printing on various types of paper, refer to "[Paper precautions by type\(P.72\)](#)".

Media Type	Paper size	Paper weight	Other conditions
Plain	A4	For simplex printing: 60 - 256 g/m ²	The custom-sized paper must meet the requirements for plain paper. B6 half, B7, B8 and 4 x 6 inches paper are not applicable to duplex printing.
	A5		
	A6	For duplex printing: 64 - 176 g/m ²	
	B5		
	B6		
	B6 Half		
	B7		
	B8		
	Letter		
	Legal (13 inches)		
	Legal (13.5 inches)		
	Legal (14 inches)		
	Executive		
	Statement		
	8.5-inch SQ		
	Folio (210 x 330 mm)		
	16K (184 x 260 mm)		
	16K (195 x 270 mm)		
16K (197 x 273 mm)			
4 x 6 inches			
5 x 7 inches			

Media Type	Paper size	Paper weight	Other conditions
	Long paper Custom Width: 55 - 216 Length: 91 - 1321		
Envelope	Com-9 Com-10 Monarch DL C5	Media using 24 lb paper	Media made of craft paper, electrophotographic paper or dry PPC paper. Media with the flap folded tightly. Duplex printing is not available.
Index Card	3 x 5 inches		Duplex printing is not available.
Label	A4 Letter	Total weight: 0.1 - 0.2 mm	Labels for electrophotographic printers or dry PPCs where the surface paper, adhesive, and backing are not degraded by heat. Media with a structure that prevents the front paper from peeling off from the backing in the heat fixing process of the printer. Media with a structure that prevents the front paper from peeling off the backing when the paper is traveling. Media with a combined weight of 0.1 to 0.2 mm of front paper and backing. Media whose surface paper covers the entire backing sheet with no adhesive sticking out. Media with no breaks or creases. Duplex printing is not available.
Partially printed paper	Equivalent to plain paper	64 - 256 g/m ²	Media that meets the requirements for plain paper. Media whose ink used for partial printing is heat resistant and can withstand 230°C.
Colored paper	Equivalent to plain paper	64 - 256 g/m ²	Media whose pigment or ink used to color the paper is heat resistant and can withstand 230°C. Media made of electrophotographic paper with the same features as plain paper.
Long paper	Width: 210 mm Length: 356 to 1320 mm	128 g/m ²	If the length of the paper exceeds 356 mm, the width must range from 210 mm to 216 mm.



- If the paper grain direction does not match the paper feeding direction, paper jams may occur.
- Printing from the MP tray may cause wrinkles. In this case, feed paper from the paper cassette.
- The paper wrapper shows the orientation of the surface. Load paper properly so that the face side is the printing side.
- The paper is wrapped in moisture-proof paper to prevent moisture. Please use the paper as early as possible after opening its package.
- Wrap unused paper in the wrapping paper, and keep it away from moisture absorption as much as possible.
- If it is used beyond the normal room temperature (temperature: 17°C to 25°C; humidity: 40% to 60%), the printing quality may be degraded or problems may occur such as paper jams, wrinkles, curls, and warpage.
- Depending on the installation environment of the machine, printing on paper that contains moisture may cause white steam or water droplets to appear around the paper exit area of the machine. This is not abnormal because the heat generated when the toner is fixed to the paper evaporates the moisture contained in the paper.

Inapplicable paper

Do not use the following types of paper. Doing so may cause paper jams or malfunction.

- Paper with smooth surface, rough paper, and paper with different front and back roughness
- Paper that is too thin or too thick
- Paper with much paper dust
- Short grain paper (Do not use for vertical feeding.)
- Wet (damp) paper
- Paper with curl, curve or wave due to humidity
- Paper stuck by static electricity
- Paper and envelopes that have been textured, embossed or coated
- Paper specially processed with glue, chemicals, etc.
- Paper specially processed without heat resistance (230°C)
- Paper with holes, perforations, notches, holes for binder
- Paper that has irregularities, crushing, burrs, etc. on the paper cut surface
- Non-square shaped paper, or paper whose cutting angle is not right
- Paper or envelopes with wrinkles, warping, corner bending, waving, creases, tears, etc.
- Paper with staples, clips, ribbons, tapes, clasps, etc.
- Special paper such as carbon paper, non-carbon paper, thermal paper, and pressure-sensitive paper
- Thermal transfer printer paper, ink jet paper, wet PPC paper, copying paper, Japanese paper, etc.
- Envelopes stucked with stamps
- Envelopes that are too thick
- Envelope made of plastic
- Double envelopes with inner bags
- Envelopes with clasps, buttons or windows
- Envelopes stucked with double-sided tape or with adhesive on the flap
- Envelopes with water repellency

Paper precautions by type

Plain

- The printing speed will be slowed when the paper size is set to [A6] or [A5] (lengthwise direction) or when the paper width is set to 182 mm or less.
- For thick paper, the toner may stick thinly to the whole paper or the printing may be light.

Partially printed paper

- When a printing frame is set, design it with careful considerations of the following variations in the printing position.
Output position accuracy: ± 2 mm; paper slant: ± 1 mm/100 mm; image expansion and contraction: ± 1 mm/100 mm (When GSM paper weight is 80 g/m²)
- This machine cannot print over a printed area.

Envelope

- The paper may warp or wrinkle after printing.
- The toner may stick thinly to the whole paper or the printing may be light.

- The toner may be easily removed.
- The printing quality may decline in an area of about 5 mm around the sealing part (of different weights) of the envelope.
- The warps on an envelope may cause poor paper feeding. Use the envelope after correcting warps or bulges.
- If the glued part at the rear edge of the envelope is bent, it may cause poor paper feeding. Correct the bending before use.
- Duplex printing is not available.
- Always perform trial printing and check that there are no problems.

Label

- The toner may stick thinly to the whole paper or the printing may be light.
- The toner may be easily removed.
- The warps on the front edge of a label may cause poor paper feeding. Use labels after correcting warps or bulges.
- Duplex printing is not available.
- Always perform trial printing and check that there are no problems.

Long paper

- For thick paper, the toner may stick thinly to the whole paper or the printing may be light.
- If the paper grain direction does not match the paper feeding direction, paper jams may occur.
- Do not use paper that has been printed once with a thermal transfer printer, inkjet printer, etc.
- The paper wrapper shows the orientation of the surface. Load paper properly so that the face side is the printing side.
- The paper is wrapped in moisture-proof paper to prevent moisture. Please use the paper as early as possible after opening its package.
- If the paper has a GSM weight other than 128 g/m², the print quality may deteriorate. Always perform trial printing and check that there are no problems.
- Be sure to set the paper size to portrait length. The portrait length cannot be set to a value shorter than the landscape length.
- Some applications may not be available.
- Even when using under the recommended conditions, the long paper with a length exceeding 356 mm may not be able to guarantee the print quality.

Irregular-sized paper (custom size)

- Skewing, curling, warping, folded corners (the edge is folded) and paper jams caused by these factors may occur. Check the print result of the paper to be used in advance.
- Register the paper in portrait orientation and load it in portrait orientation in the tray.
- If the length exceeds 356 mm, use the rear output tray.
- Some applications may not be available.
- The quality of printing on the paper with a length exceeding 356 mm will be not guaranteed.
- If the paper is too long and protrudes from the paper supporter of the MP tray, support the paper with your hand.
- For the paper size that can be fed from each tray and the paper size that can be printed on both sides, please refer to "[Applicable paper](#)(P.70)".

- If you cannot print correctly on a large-sized paper, it is suggested to set [Quality] to [Normal] in the PS printer driver.
- Always perform trial printing and check that there are no problems.

Recycled

- The toner may stick thinly to the whole paper or the printing may be light.
- Some recycled paper contains additives that may reduce the printing quality. Be sure to check that it is the recycled paper for the electrophotographic printer before using it.

Paper applicable to each tray

Tray 1

Media type	Media size	Media weight	Applicable number of sheets
Plain Partially printed paper Colored paper	A4, A5, A6, B5, B6, Letter, Legal (13 inches), Legal (13.5 inches), Legal (14 inches), Executive, Statement, 8.5-inch SQ (8.5 x 8.5 inches), Folio (210 x 330 mm), 16K (184 x 260 mm), 16K (195 mm x 270 mm), 16K (197 x 273 mm), 5 x 7 inches, custom size (width: 100 - 216 mm; length: 148 - 356 mm)	60~256 g/m ²	250 (When the paper weight is 80 g/m ²)

Tray 2/3/4 (Optional)

Media type	Media size	Media weight	Applicable number of sheets
Plain Partially printed paper Colored paper	A4, A5, A6, B5, B6, Letter, Legal (13 inches), Legal (13.5 inches), Legal (14 inches), Executive, Statement, 8.5-inch SQ (8.5 x 8.5 inches), Folio (210 x 330 mm), 16K (184 x 260 mm), 16K (195 mm x 270 mm), 16K (197 x 273 mm), 5 x 7 inches, custom size (width: 105 - 216 mm; length: 148 - 356 mm)	64~176 g/m ²	530 (When the paper weight is 80 g/m ²)

MP tray

Media type	Media size	Media weight	Applicable number of sheets
Plain Envelope Label Index Card Partially printed paper Color paper	A4, A5, A6, B5, B6, B6 Half, B7, B8, Letter, Legal (13 inches), Legal (13.5 inches), Legal (14 inches), Executive, Statement, 8.5-inch SQ (8.5 x 8.5 inches), Folio (210 x 330 mm), 16K (184 x 260 mm), 16K (195 mm x 270 mm), 16K (197 x 273 mm), 4 x 6 inches, 5 x 7 inches, Com-9, Com-10, Monarch, DL, C5, custom size (width: 55 - 216 mm; length: 91 - 1,321 mm)	60~256 g/m ²	100 (When the paper weight is 80 g/m ²) 10 (When the envelope weight is 80g/m ²)

Loading paper in Tray 1

For the paper that can be used, please see "[Applicable paper\(P.70\)](#)", "[Paper applicable to each tray\(P.74\)](#)".



- You can load the A5-sized paper in either portrait or landscape.

1 Pull out the paper cassette.

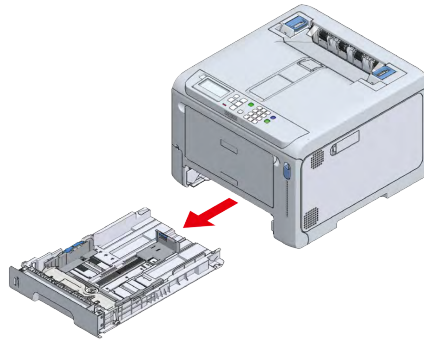

- If you pull out the paper cassette with the power on, "Change tray settings?" may appear on the display. This message will disappear automatically in 10 seconds after the paper cassette is returned to the main unit. If you have changed the paper, press the «OK» button and change the settings of paper size, media type and media weight accordingly.
- Be cautious for the orientation of paper that can be loaded in either portrait or landscape, like A5 size.

2 Slide the paper guide and the blue part of the paper stopper to fit the size of the paper to be loaded.

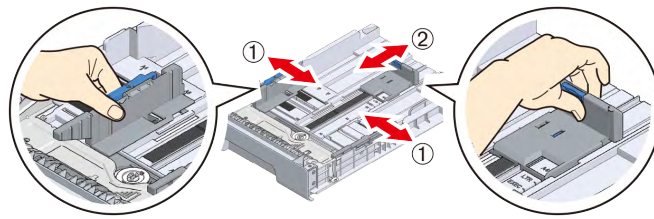

3 Shuffle the paper well. Align edges of the paper horizontally.

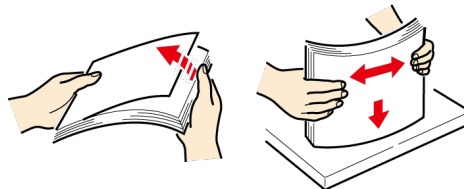

4 Load the paper with the printing side down, and press it down from top.



- Do not exceed the ▽ mark on the paper guide when loading paper.

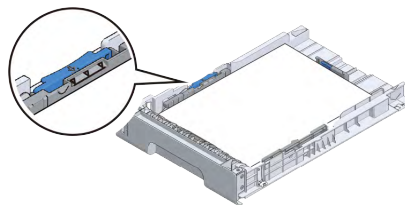

5 Return the paper cassette to this machine.



- If the paper cassette is returned to the main unit forcefully, the paper stopper may slide.

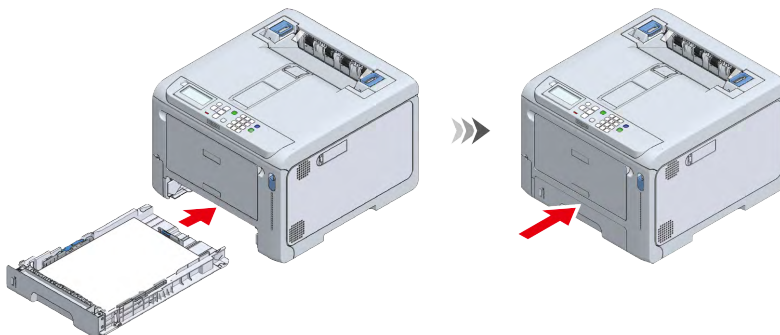

6 Proceed to "Setting paper information on the operator panel(P.79)".

Loading paper in Tray 2/3/4 (Optional)

For the paper that can be used, please see "Applicable paper(P.70)" , "Paper applicable to each tray(P.74)".



- You can load the A5-sized paper in either portrait or landscape.

1 Pull out the paper cassette.

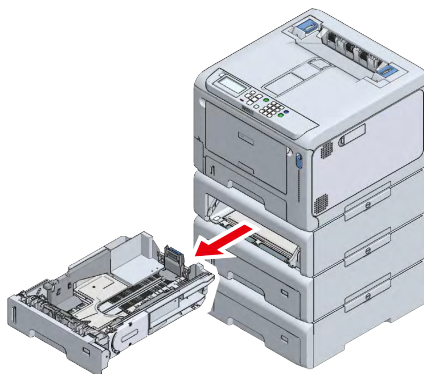

2 Set the paper size dial to fit the paper size.

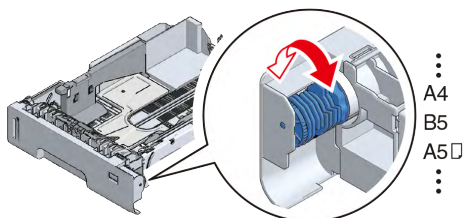

- Set it to [OTHER] when you have loaded the paper of a standard size not available on the paper size dial.



- If you pull out the paper cassette with the power on, "Change tray setting?" may appear on the display. This message will disappear automatically in 10 seconds after the paper cassette is returned to the main unit. If you have changed the paper, press [Yes] and change the settings of paper size, media type and media weight accordingly. Also, change the setting of the paper size dial of the tray.
- Make sure that the setting of the paper size dial matches the size of paper to be loaded. If they do not match, a paper size error will occur, and you will be unable to print.

- Be cautious for the orientation of paper that can be loaded in either portrait or landscape, like A5 size.

3 Slide the paper guide and the blue part of the paper stopper to fit the size of the paper to be loaded.

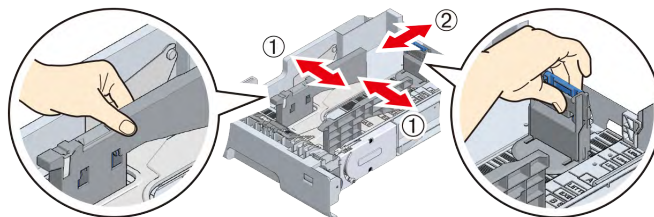

4 Shuffle the paper well. Align edges of the paper horizontally.

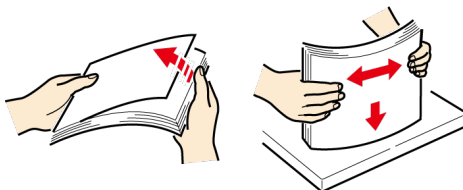

5 Load the paper with the printing side down, and press it down from top.



- Do not exceed the ▽ mark on the paper guide when loading paper.

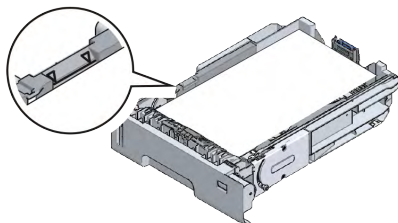

6 Check that the size and orientation of the loaded paper well match the settings of the paper size dial.



- If the size and the orientation of the loaded paper do not match the settings of the paper size dial, a paper size error may occur during printing and you may not be able to print.

7 Return the paper cassette to this machine.



- If the paper cassette is returned to the main unit forcefully, the paper stopper may slide.

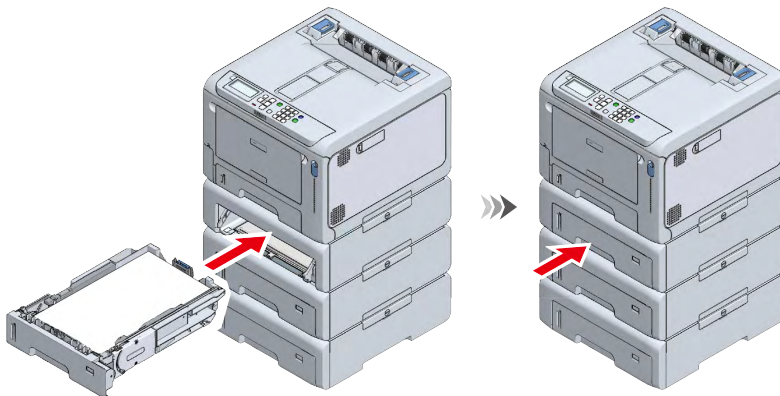

8 Proceed to "[Setting paper information on the operator panel\(P.79\)](#)".

Loading paper in the MP tray

For the paper that can be used, please see "[Applicable paper\(P.70\)](#)" and "[Paper applicable to each tray\(P.74\)](#)".



- Do not load paper of different sizes, types, and weight at the same time.
- When adding paper, remove the paper in the MP tray, align edges of the paper and the paper to be added, and then load them together.
- Do not insert anything other than print paper into the MP tray.
- Do not leave paper in the MP tray for an extended period of time. Dust and dirt will adhere to the paper, and the print quality will degrade.



- You can load the A5-sized paper in either portrait or landscape.

- 1 Place your fingers in the front recess and pull to open the MP tray towards you.

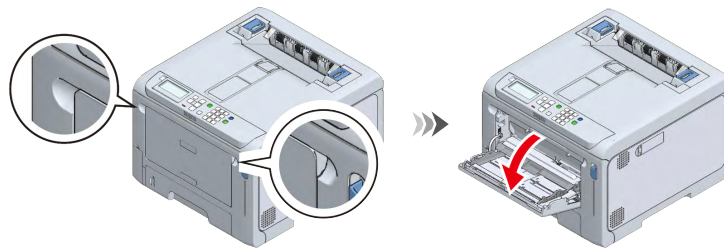

- 2 Hold the center of the paper supporter and pull it out towards you.

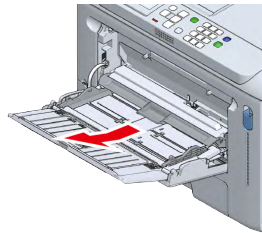

- 3 Open the auxiliary supporter.

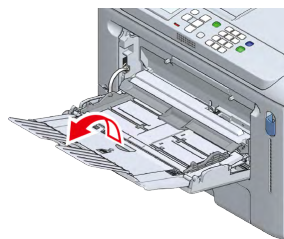

- 4 Move the paper placement cover upward.

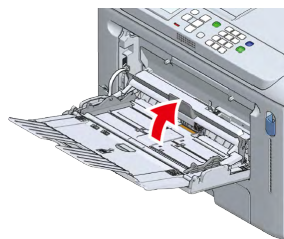

- 5 Adjust the manual feeder guide to the width of the paper to be loaded.

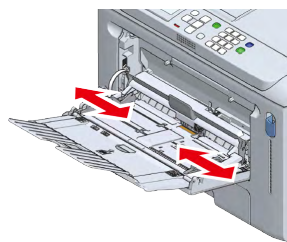

- 6 Shuffle the paper well. Align edges of the paper horizontally.

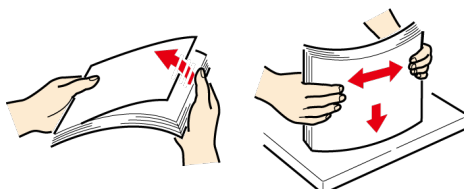

- 7 Load the paper with the print side facing up.



- Do not exceed the ▽ mark on the paper guide when loading paper.

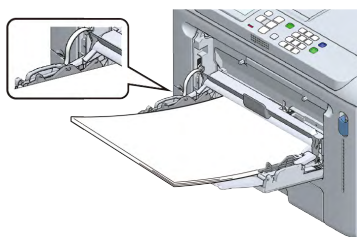

- "Would you like to change the tray settings?" may appear on the display. This message will disappear automatically after 10 seconds. If you have changed the paper, press «OK» and change the settings of paper size, media type and media weight accordingly.

- 8 Move the paper placement cover downward.



- The paper cannot be fed without lowering the paper placement cover.

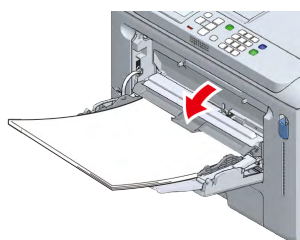

If you always print on paper of the same size and type from the MP tray, register the loaded paper in this machine.

Proceed to "[Setting paper information on the operator panel](#)(P.79)".

Setting paper information on the operator panel

Set the size, type and weight of the paper loaded in each tray in order.

When envelopes are loaded, see "Printing on envelopes (User's Manual)".

When labels are loaded, see "Printing on labels (User's Manual)".

When long paper is loaded, see "Printing on long paper (User's Manual)".

When irregular-sized paper is loaded, see "Printing on irregular-sized paper (custom size) (User's Manual)".



- If the machine is in the power save mode, press «POWER SAVE» to restore.
- For details about the short cut menu, see "[Setting with the short menu \(Fn key\)\(P.92\)](#)".

For Tray 1/the MP tray

- 1 Check that "Ready To Print" appears on the display.
- 2 To set the paper size of Tray 1, press the keys in the following order: «Fn» → «1» → «0» → «OK».
To set the paper size of the MP tray, press the keys in the following order: «Fn» → «9» → «0» → «OK».
- 3 Press the scroll button ▲ or ▼ to select the paper size to set, and press «OK» and then «BACK».
- 4 Press «2» to display [Media Type], press ▲ or ▼ to select the paper type to set, and press «OK» and then «BACK».
- 5 Press «3» to display [Media Weight], press ▲ or ▼ to select the paper type to set, and press «OK» and then «BACK».
- 6 Press «ON LINE» to return to the standby screen.

For Tray 2/3/4

- 1 Check that "Ready To Print" appears on the display.
- 2 To set the paper size of Tray 2, press the keys in the following order: «Fn» → «2» → «0» → «OK».
To set the paper size of Tray 3, press the keys in the following order: «Fn» → «3» → «0» → «OK».
To set the paper size of Tray 4, press the keys in the following order: «Fn» → «4» → «0» → «OK».
- 3 Press ▲ or ▼ to select [Cassette Size], and press «OK» and then «BACK».
- 4 If the paper size dial of the tray is set to any other option than [OTHER], proceed to Step 5.
If [OTHER] is set, press «4» to display [Other Size]. Press ▲ or ▼ to select the paper size to set, and press «OK» and then «BACK».
- 5 Press «2» to display [Media Type]. Press ▲ or ▼ to select the paper type to set, and press «OK» and then «BACK».
- 6 Press «3» to display [Media Weight]. Press ▲ or ▼ to select the paper type to set, and press «OK» and then «BACK».
- 7 Press «ON LINE» to return to the standby screen.

About values to be set

Refer to the following table for settings in the case of plain, partially printed paper and colored paper.

Values to be set on the operator panel	
Media type	Media weight
Plain	60 - 63 g/m ² paper: Ultra Light 64 - 74 g/m ² paper: Light 75 - 82 g/m ² paper: Medium Light 83 - 90 g/m ² paper: Medium 91 - 104 g/m ² paper: Medium Heavy 105 - 120 g/m ² paper: Heavy 121 - 176 g/m ² paper: Ultra Heavy 1 177 - 220 g/m ² paper: Ultra Heavy 2 221 - 256 g/m ² paper: Ultra Heavy 3

Refer to the following table for settings in the case of index cards.

Values to be set on the operator panel	
Paper size	Media weight
Index Card	60 - 63 g/m ² : Ultra Light 64 - 74 g/m ² : Light 75 - 82 g/m ² : Medium Light 83 - 90 g/m ² : Medium 91 - 104 g/m ² : Medium Heavy 105 - 120 g/m ² : Heavy 121 - 176 g/m ² : Ultra Heavy 1 177 - 220 g/m ² : Ultra Heavy 2 221 - 256 g/m ² : Ultra Heavy 3

Storing paper

Please keep the paper under the following conditions to maintain the quality.

- A dark and flat place with low humidity
- Temperature: 20°C
- Humidity: 50% RH (relative humidity)

Do not store in any of the following places.

- Places exposed to direct sunlight
- Places with extreme rises and sudden fluctuations in temperature
- Places near copiers, air conditioners, heaters, ducts, etc.
- Places near the inside of an outer wall
- Uneven or curved surfaces
- Directly on the floor
- Places where static electricity is generated



- Do not open the paper until you use it.
- Do not leave the paper exposed to the air for a long period of time. You may not be able to print correctly.
- Depending on the paper in use, operating conditions and storage conditions, the print quality may deteriorate, or the paper may be curled or wrinkled.

Setting the output bin

This machine outputs paper to the output tray or rear output tray. The following types of paper can be output to each output tray.

Output bin	Types of paper to output	Number of sheets to output
Output tray	Plain, recycled paper	150 (80 g/m ²)
Rear output tray	Plain, recycled paper, envelope, Index Card, labels, long paper	100 (80g/m ²) 10 (envelopes/card stocks)



- Do not open or close the output tray during printing. Doing so may cause a paper jam.

Output tray

The paper is output with the printing side down in the order in which they are printed.



- Check that the rear output tray at the back of this machine is closed. When the rear output tray is open, paper will always be output to the rear output tray.

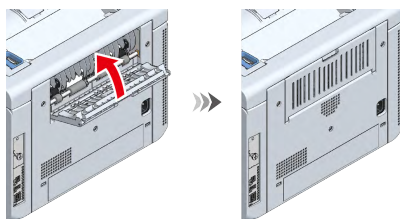

When the printed paper does not stack well, lift the paper supporter. There are two paper supporters, but only either of them is used according to your environment.

- When lifting the paper supporter on the front side

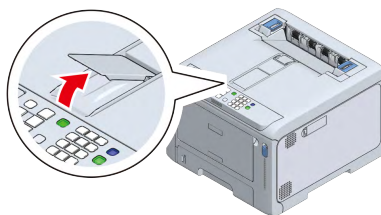

- When lifting the paper supporter on the back side

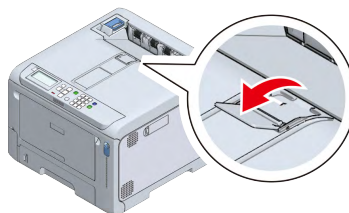

Rear output tray

Use the rear output tray to print on envelopes, labels or custom-sized paper.

The paper is output with the printing side up in the reverse order to which they are printed.

- 1 Open the rear output tray at the back of this machine.

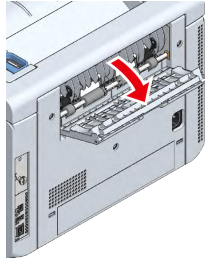

- 2 Open the paper supporter.

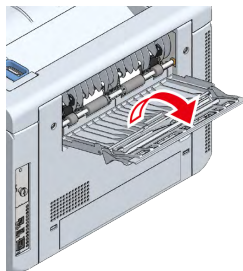

- 3 Pull out the auxiliary supporter.

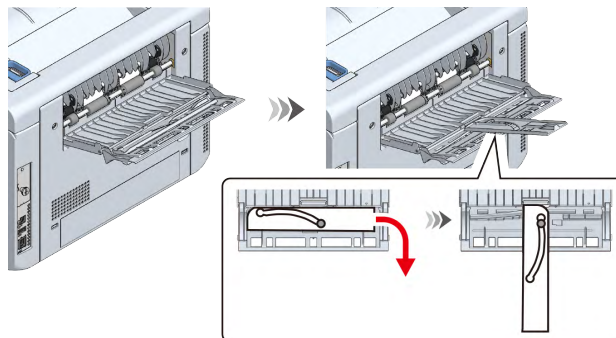

Checking the configuration

You can print out and check the configuration of this machine. You can also check the configuration from the operator panel.

Printing the menu map (configuration)

You can print the list of configurations (menu map) of this machine or the Printer Usage Report.

- 1 Check that "Ready To Print" appears on the display.



- If the machine is in the power save mode, press «POWER SAVE» to restore.

- 2 Press «Fn» on the operator panel.

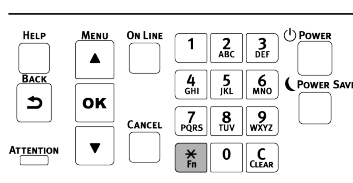

- 3 On the function number screen, press «1», «0», «0» and finally «OK».

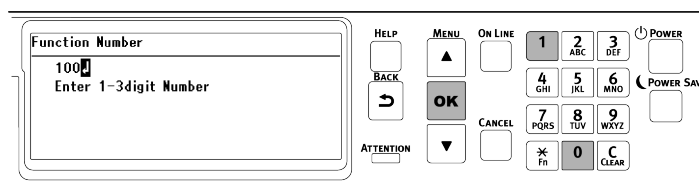

- 4 Make sure that [Configuration] is displayed and [Execute] is selected, and press «OK».

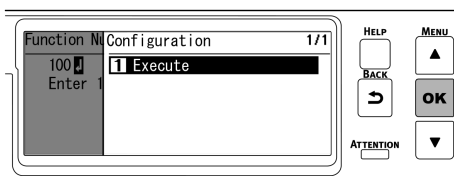

- 5 The configuration is printed .

How to read the configuration

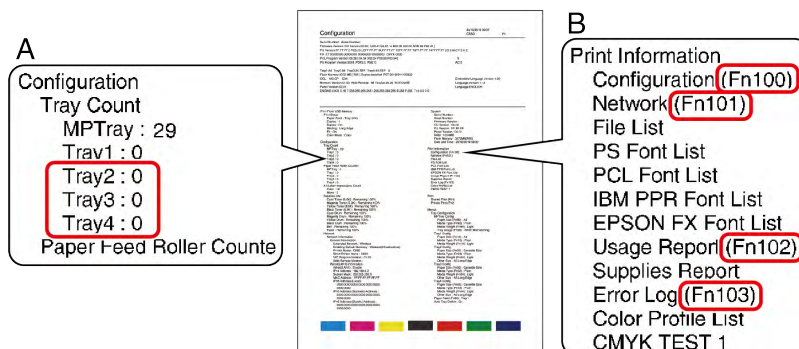

A	Displays the options that have been installed.
B	Displays the function number. Setting with the short menu (Fn key)(P.92)



- For the information not listed in [Configuration], see "Menu list (User's Manual)" - [Print Information].

Confirming on the operator panel

You can check the supplies status and counter information on the operator panel.

- 1 Check that "Ready To Print" appears on the display.



- If the machine is in the power save mode, press «POWER SAVE» to restore.

- 2 Press the scroll button ▼ on the operator panel several times to select [Configuration], and press «OK».
- 3 Select the item that you want to check, and press «OK».
- 4 Select the information that you want to check, and press «OK».
- 5 After confirming the content, press «ON LINE» to return to the standby screen.

How to use levers L1 and L2

When the front cover is open, you will find the L1 lever and the L2 lever. This section describe how to use these levers.

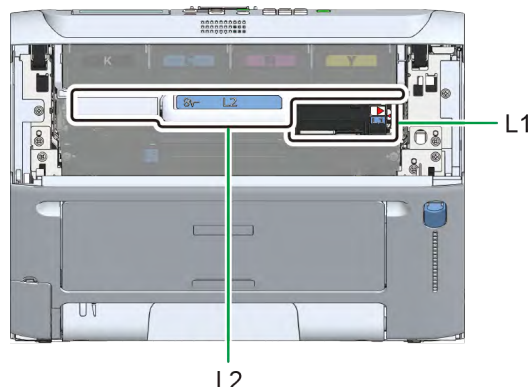

Lever L1

Used to replace the image drum and to clean the LED head.

[Replacing the image drum](#)(P.128)

[Cleaning the LED head](#)(P.137)

After opening the front cover, operate the L1 lever first and then the L2 lever.

After the operation, only the output tray is raised.

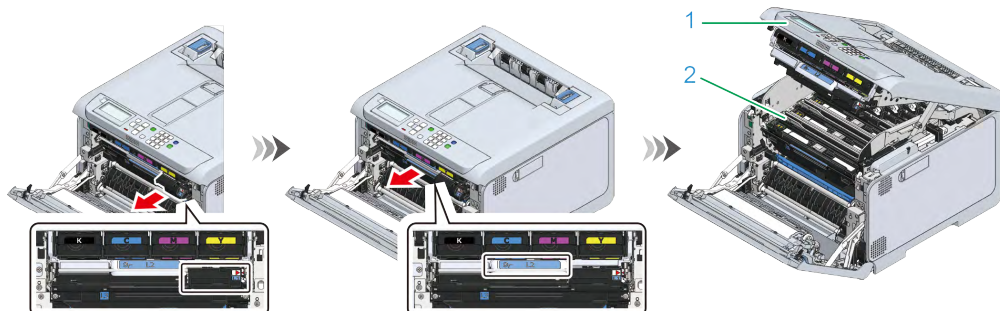

No.	Name
1	Output tray
2	Image drum basket

When closing, close the output tray first. Then, press the L1 lever, and close the front cover with your both hands firmly.

Lever L2

Used to replace the belt unit and to remove the jammed paper.

[Replacing the belt unit\(P.133\)](#)

[When paper is jammed\(P.148\)](#)

After opening the front cover, pull the L2 lever.

After the operation, both the output tray and the image drum basket are integrated and raised.

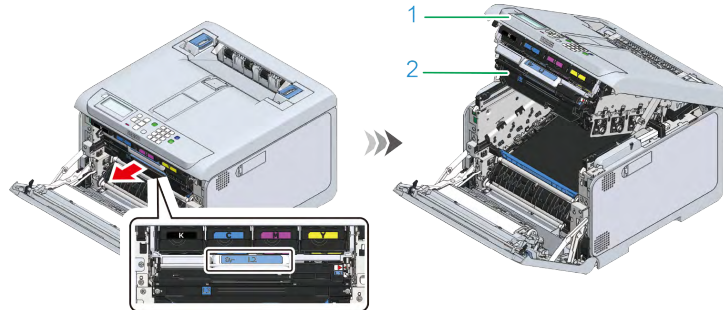

No.	Name
1	Output tray
2	Image drum basket

When closing, close the output tray first, and then close the front cover with your both hands firmly.

4

Changing settings from the operator panel

- Parts identification of the operator panel..... 89
- Adjusting the display orientation 90
- Inputting text..... 91
- Changing settings..... 92
- Adjusting the buzzer volume 95
- Setting the power save function 96

Parts identification of the operator panel

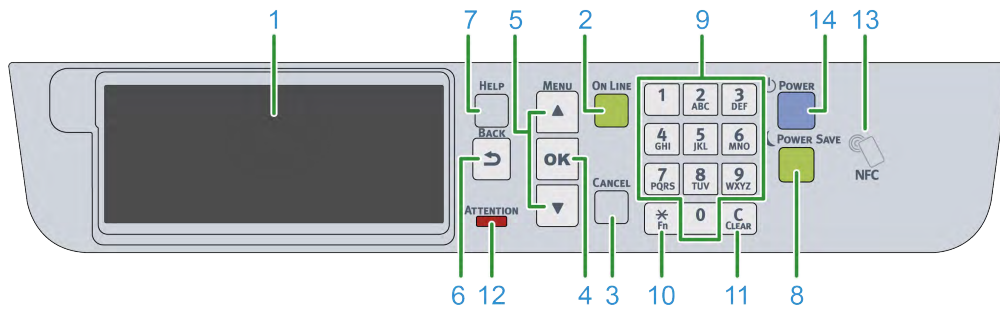

No.	Name	Function
1	Display	Displays the state of this machine and operation instructions. There are two types of standby screens: "Show Remaining Toner" and "Show Tray Information". The factory default setting is "Show Remaining Toner".
2	«ON LINE» button	Switches between online and offline. Lights green when online, and goes off when offline.
3	«CANCEL» button	Cancels the current printing. Goes back to the standby screen when the menu is displayed.
4	«OK» button	Confirms the highlighted item.
5	Scrolls buttons ▲ ▼	Used to select a menu or scroll the screen display. It can be used to input numbers in the numerical input screen.
6	«BACK» button	Goes back to the previous screen.
7	«HELP» button	Displays the help screen. To close the screen, press the «HELP» button again, or press the «BACK» or «CANCEL» button.
8	«POWER SAVE» button	Turns on or off the power save mode. Cancels the sleep mode. Lights green in the power save mode, and flashes green in the sleep mode.
9	Numeric keypad	Inputs alphanumeric characters or symbols.
10	«Fn» key	Used to display the short cut menu. Fn: The abbreviation for "Function".
11	«CLEAR» key	Long or short press the key to perform the following actions according to the item to input. <ul style="list-style-type: none"> Minimizes the settings. Inputs 0 for the settings. Deletes one character of the input text. Deletes the selected item. * Disabled when the IP address is input.
12	ATTENTION lamp	Indicates the state of this machine. Lights off in the normal state. On: Indicates that a minor error has occurred. Blinking: Indicates that a major error has occurred.
13	NFC mark	When using the NFC function, bring your mobile device close here. For details about the NFC function, see "Printing from a mobile device (User's Manual)".
14	Power switch	Turns on/off the power of this machine. Lights blue when the power is turned on, and lights off when the power is turned off.

Adjusting the display orientation

You can adjust the angle so that it is easier to watch the display.

- 1 Put your finger in the recess on the left side of the display, and raise the display towards you.

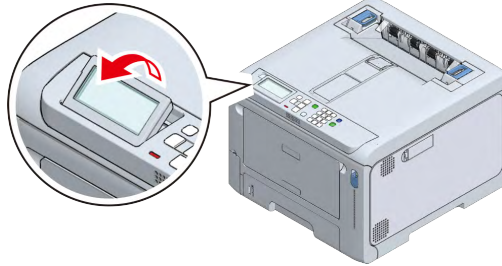

To return to the original angle, press it gently.

Inputting text

You can input alphabetic or numeric characters using the numeric keypad. If a same key is pressed in succession, the alphanumeric character will switch. To continue typing with the same key, press «OK» after inputting each alphanumeric character.

The following characters can be input when the corresponding key is pressed.

For a menu that can only input numbers, it will not switch to alphabetic characters.

Key	Text to input
«1»	1 → 1
«2»	2 → a → b → c → A → B → C → 2
«3»	3 → d → e → f → D → E → F → 3
«4»	4 → g → h → i → G → H → I → 4
«5»	5 → j → k → l → J → K → L → 5
«6»	6 → m → n → o → M → N → O → 6
«7»	7 → p → q → r → s → P → Q → R → S → 7
«8»	8 → t → u → v → T → U → V → 8
«9»	9 → w → x → y → z → W → X → Y → Z → 9
«0»	0 → (space) → 0
«*»	* → @ → . → _ → - → (space) → + → ! → " → \$ → % → & → ' → (→) → , → / → : → ; → < → = → > → ? →
«Fn»	[→ ¥ →] → ^ → # → ` → { → → } → ~ → *  <ul style="list-style-type: none"> If the setting value contains [+] and [-], you can switch between [+] and [-] by pressing it while you are inputting.

Example

To input "abc",

press «2» «2» «OK», «2» «2» «2» «OK», and «2» «2» «2»«2» «OK».

The functions of the following keys are described below.

«Fn»

Used to quickly display items of the Setting menu. When "Ready To Print" is displayed, press «Fn» and then the numeric key to display the menu item corresponding to the number.

[Setting with the short menu \(Fn key\)\(P.92\)](#)

«CLEAR»

Deletes each character individually when a password is input.

Changing settings

Setting menu display

This section describes how to change menu settings from the operator panel.



- See "Menu list (User's Manual)" for a list of menu items.

1 Check that "Ready To Print" appears on the display.



- If the machine is in the power save mode, press «POWER SAVE» to restore.

2 Press the scroll button ▲ or ▼ on the operator panel several times to select the category of the item to be set, and press «OK». Repeat until you see the category of the item to be set. The display color of the selected item is highlighted.

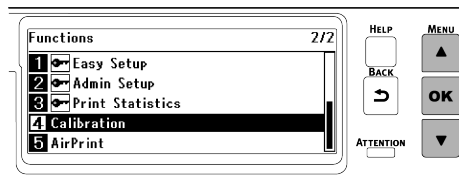

3 Press ▲ or ▼ several times to select the item to be set, and then press «OK».

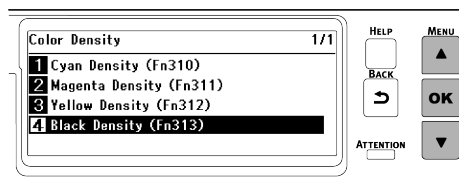

4 Use ▲/▼ or the numeric keypad to display the value to be set, and press «OK». A check mark appears to the left of the set value.

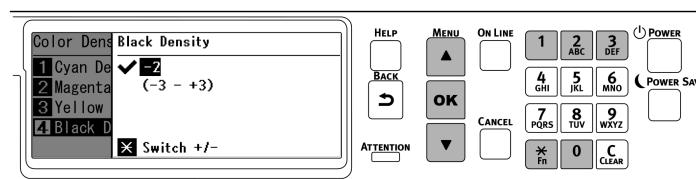

5 Press «ON LINE» to return to the standby screen.

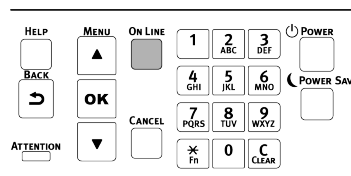

Setting with the short menu (Fn key)

When "Ready To Print" is displayed, press the «Fn» key on the operator panel, and then press any number to display the relevant menu item.



- For the number corresponding to the menu item, refer to "Function Number List".

- You can print to check the configuration.
 - [Printing the menu map \(configuration\)\(P.84\)](#)

1 Check that "Ready To Print" appears on the display.



- If the machine is in the power save mode, press «POWER SAVE» to restore.

2 Press «Fn» on the operator panel.

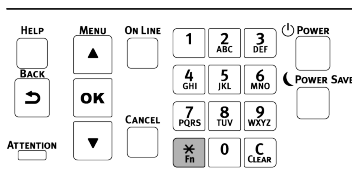

3 Since it will be a function number screen, input the number of the menu you want to display using the numeric keypad, and press «OK».

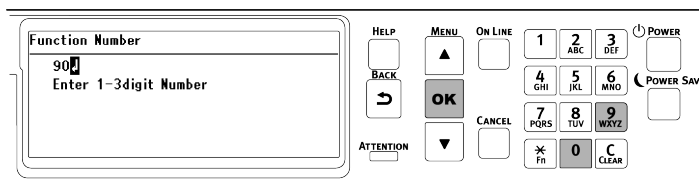

4 When the menu is displayed, check or change the settings.

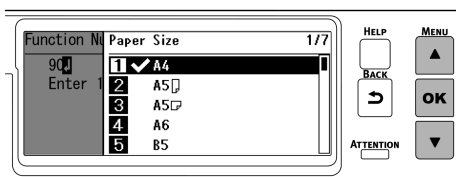

Function Number List

Function No.	Corresponding menu item
1	Shared Print (Stored Job)
2	Private Print (Encrypted Job)
10	Media Size (Tray 1)
11	X Dimension (Tray 1)
12	Y Dimension (Tray 1)
13	Media Type (Tray 1)
14	Media Weight (Tray 1)
20	Media Size (Tray 2)
21	X Dimension (Tray 2)
22	Y Dimension (Tray 2)
23	Media Type (Tray 2)
24	Media Weight (Tray 2)
30	Media Size (Tray 3)
31	X Dimension (Tray 3)
32	Y Dimension (Tray 3)
33	Media Type (Tray 3)
34	Media Weight (Tray 3)
40	Media Size (Tray 4)
41	X Dimension (Tray 4)
42	Y Dimension (Tray 4)

Function No.	Corresponding menu item
43	Media Type (Tray 4)
44	Media Weight (Tray 4)
80	Paper Tray
90	Media Size (MP tray)
91	X Dimension (MP tray)
92	Y Dimension (MP tray)
93	Media Type (MP tray)
94	Media Weight (MP tray)
95	Tray Usage (MP tray)
100	Print Information (Menu Map (Configurations))
101	Print Information (Network)
102	Print Information (Printer Usage Report)
103	Print Information (Error Log)
200	Power Save Time
201	Sleep Time
202	Auto Power Off Time
210	Error Report
220	Print Position Adjust (MP tray)
221	Print Position Adjust (Tray 1)
222	Print Position Adjust (Tray 2)
223	Print Position Adjust (Tray 3)
224	Print Position Adjust (Tray 4)
230	Paper Black Setting
231	Paper Color Setting
232	Trans. Black Setting
233	Trans. Color Setting
234	SMR Setting
235	BG Setting
236	Drum Cleaning
237	Hex Dump
300	Adjust Density
301	Adjust Registration
302	Print Color Tuning Pattern
310	Cyan Density
311	Magenta Density
312	Yellow Density
313	Black Density



- If the function number of an optional part that is not installed is specified, [Invalid Number] is displayed.



- For a list of menu items, see "Menu list (User's Manual)".

Adjusting the buzzer volume

The volume of the following buzzers is adjustable in three steps.

- Paper jam buzzer
- Printing completion buzzer
- Buzzer for AirPrint printing
- IC Card hold buzzer

- 1** Press the scroll button ▼ on the operator panel several times to select [Admin Setup], and press «OK».
- 2** Input the admin password using the numeric keypad, and press «OK».
[Admin password](#)(P.114)
- 3** Press ▼ or ▲ several times to select [Buzzer Setup], and press «OK».
- 4** Press ▼ or ▲ several times to select the item to change, and press «OK».
- 5** Adjust the volume of the selected item, and press «OK».
- 6** Press «ON LINE» to return to the standby screen.

Setting the power save function

Setting the time that elapses before entering the power save mode

This machine automatically enters the power save mode (an energy saving mode) if no operation is done for a certain period of time.

The following time can be set. The factory default setting is 1 minutes.

1 min, 2 mins, 3 mins, 4 mins, 5 mins, 10 mins, 15 mins, 30 mins, and 60 mins



- This machine may not enter the power save mode after the set period of time since the fan is working until this machine has cooled down depending on the printing environment or the usage conditions.

1 Check that "Ready To Print" appears on the display.



- If the machine is in the power save mode, press «POWER SAVE» to restore.

2 Press «Fn» on the operator panel.

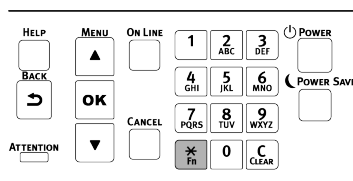

3 Input «2», «0» and «0» using the numeric keypad, and press «OK».

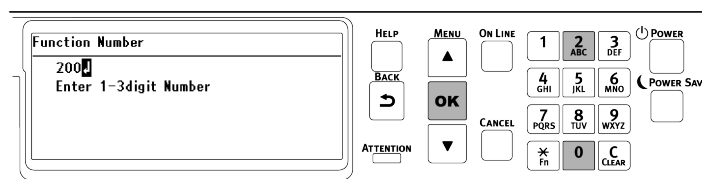

4 Press the scroll button ▲ or ▼ to select the time to set, and press «OK».

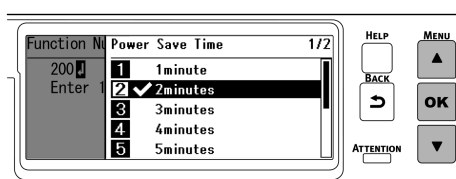

5 Press «ON LINE» to return to the standby screen.

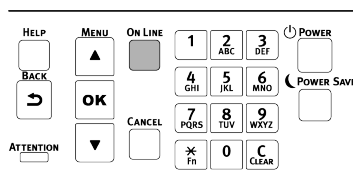

Setting the time that elapses before entering the sleep mode

This machine automatically enters the sleep mode (a more energy saving mode) if no operation is done for a certain period of time in the power save mode.

The following time can be set. The factory default setting is 15 minutes.

1 min, 2 mins, 3 mins, 4 mins, 5 mins, 10 mins, 15 mins, 30 mins, and 60 mins



- This machine may not enter the sleep mode after the set period of time since the fan is working until this machine has cooled down depending on the printing environment or the usage conditions.

1 Check that "Ready To Print" appears on the display.



- If the machine is in the power save mode, press «POWER SAVE» to restore.

2 Press «Fn» on the operator panel.

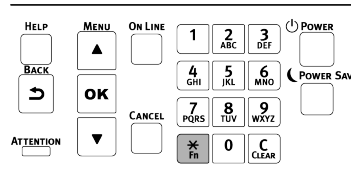

3 Input «2», «0» and «1» using the numeric keypad, and press «OK».

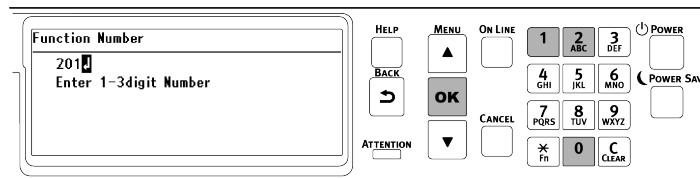

4 Press the scroll button ▲ or ▼ to select the time to set, and press «OK».

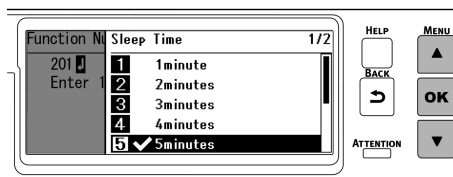

5 Press «ON LINE» to return to the standby screen.

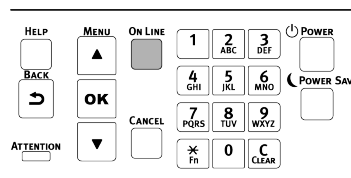

Restrictions of the power save function

The sleep mode will not be entered in the following cases.

- When an error has occurred to this machine
- When access control is enabled for the access control settings, and local IC card authentication or LDAP IC card authentication is enabled for the authentication method

Turning off the power automatically (Auto Power Off)

This machine comes with a function (Auto Power Off) to turn off the power automatically if it has not been used for a certain period of time.

There are 3 types of settings for Auto Power Off, and the default factory setting is [Auto Config].

- [Auto Config]: The power is turned off automatically if the machine has not been used for a certain period of time, except in the following situations.
 - When the LAN cable is connected to the network interface connector
 - When the wireless LAN is enabled
- [Enable]: The power is automatically turned off if this machine has not been used for a certain period of time.
- [Disable]: Disables the Auto Power Off function. The power does not turn off automatically.



- Auto Power Off does not work in the following cases.
 - With the factory default settings, Auto Power Off does not work when a network (wired/wireless) is connected.
 - When an error has occurred

Follow the procedure below to change the Auto Power Off setting.

1 Check that "Ready To Print" appears on the display.



- If the machine is in the power save mode, press «POWER SAVE» to restore.

2 Press the scroll button ▼ on the operator panel several times to select [Admin Setup], and press «OK».

3 Input the admin password using the numeric keypad, and press «OK».

[Admin password](#)(P.114)

4 Press ▼ several times to select [Power Setup], and press «OK».

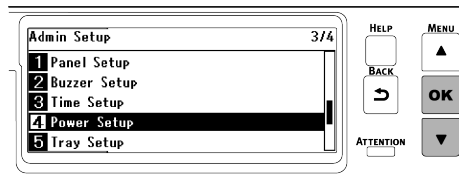

5 When [Auto Power Off] is displayed, press «OK».

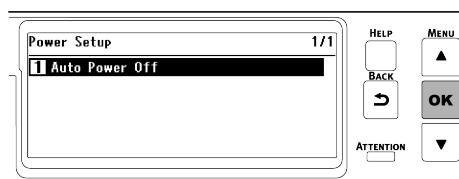

6 Press ▲ or ▼ to select [Auto Config], [Enable] or [Disable], and press «OK».

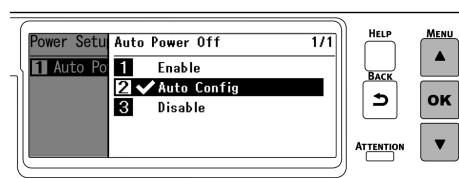

7 Press «ON LINE» to return to the standby screen.

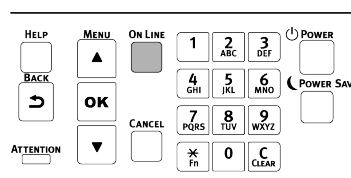

Setting the time that elapses before entering the auto power off mode

The following time can be set. The factory default setting is 4 hours.

1 hour, 2 hours, 3 hours, 4 hours, 8 hours, 12 hours, 18 hours, and 24 hours

- 1 Check that "Ready To Print" appears on the display.



- If the machine is in the power save mode, press «POWER SAVE» to restore.

- 2 Press «Fn» on the operator panel.

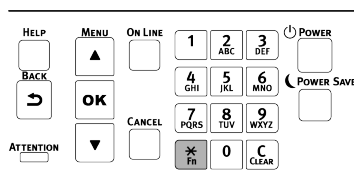

- 3 Input «2», «0» and «2» using the numeric keypad, and press «OK».

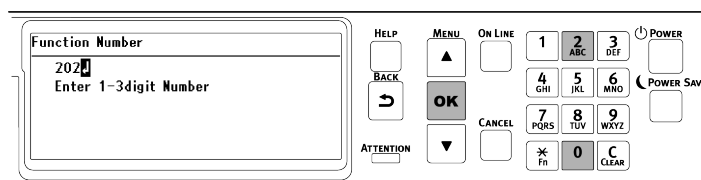

- 4 Press the scroll button ▲ or ▼ to select the time to set, and press «OK».

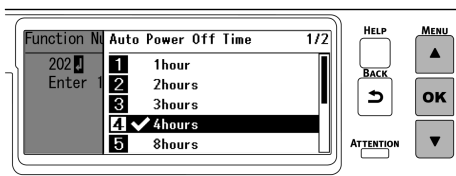

- 5 Press «ON LINE» to return to the standby screen.

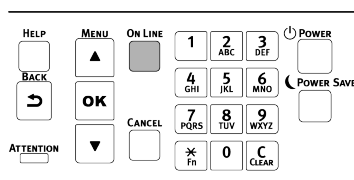

5 Printing

Printing from a PC	101
Screens and functions of the printer driver	103

Printing from a PC

For Windows PCL printer driver

- 1 Open the file to be printed.
- 2 Select [Print] from the [File] menu.
- 3 Select [OKI C650 PCL6] from [Select Printer].
- 4 Click [Preferences] (or [Properties]).

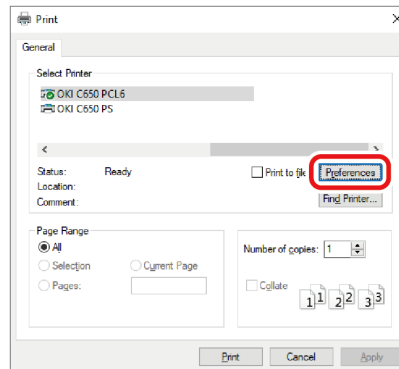

- 5 Select the loaded paper size from [Size] in the [Setup] tab.

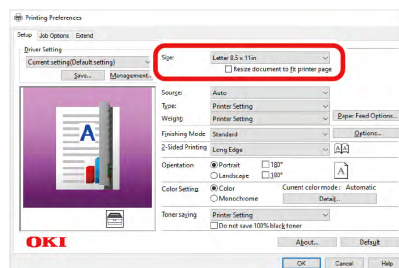

- 6 Select the tray to be printed from in [Source].
 - If you cannot select Tray 2/3/4, see "[Setting the printer driver\(P.62\)](#)".
- 7 Set [Type] and [Weight].
- 8 Set other necessary items.
- 9 Click [OK].
- 10 Printing starts.

For Windows PS printer driver

- 1 Open the file to be printed.
- 2 Select [Print] from the [File] menu.
- 3 Select [OKI C650 PS] from [Select Printer].
- 4 Click [Preferences] (or [Properties]).

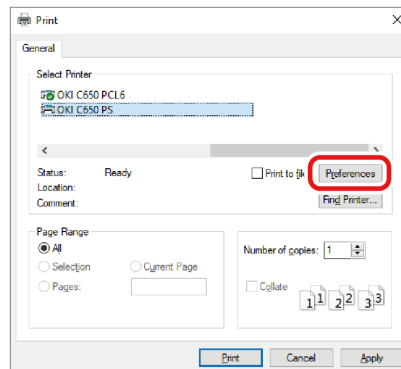

- 5 Select the [Paper/Quality] tab.
- 6 Select the tray to be printed from in [Paper Source].
 - If you cannot select Tray 2/3/4, see "[Setting the printer driver\(P.62\)](#)".
- 7 Click [Advanced].
- 8 Click [Paper Size], and select the loaded paper size from the drop-down list.
- 9 Set other necessary items.
- 10 Click [OK].
- 11 Printing starts.

For macOS

- 1 Open the file to be printed.
- 2 Select [Page Setup] from the [File] menu.
- 3 Select the loaded paper size from [Media Size], and click [OK].
- 4 Select [Print] from the [File] menu.
- 5 Select [Paper Feed] from the panel menu.
- 6 Select [All Pages From], and select the tray to be printed from.
 - If you cannot select Tray 2/3/4, see "[Setting the printer driver\(P.62\)](#)".
- 7 Set other necessary items.
- 8 Printing starts.

Screens and functions of the printer driver

Windows PCL printer driver

[Setup] tab

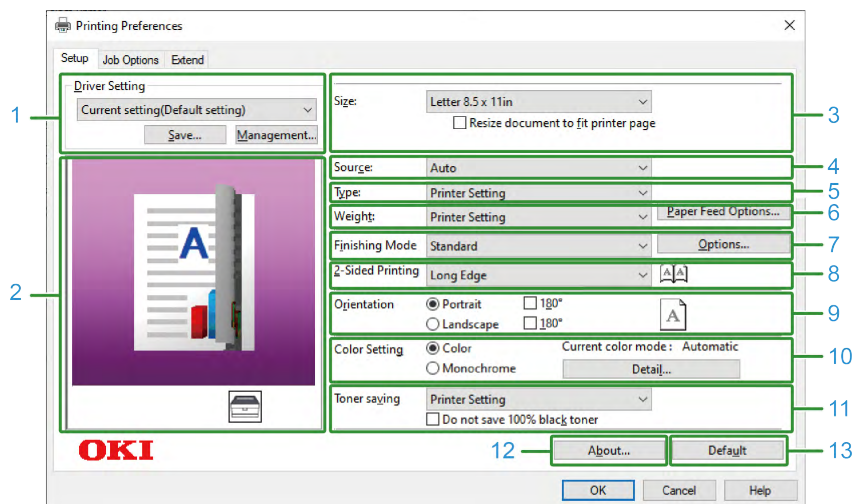

No.	Item	Description
1	Driver settings	Save the settings.
2	Layout image	Displays a sample image of the print layout.
3	Size	Sets the media size.
4	Source	Sets the paper source.
5	Type	Sets the media type.
6	Weight	Sets the media weight.
7	Finishing Mode	Sets multicast printing, booklet printing, poster printing, etc.
8	2-Sided Printing	Sets the duplex printing.
9	Orientation	Sets the printing orientation.
10	Color Setting	Switches between color printing and mono printing.
11	Toner saving	Decreases the print density to reduce the amount of toner to be used.
12	About	Displays the version of the printer driver.
13	Default	Restores the settings of each item in the tab to the initial values.

[Job Options] tab

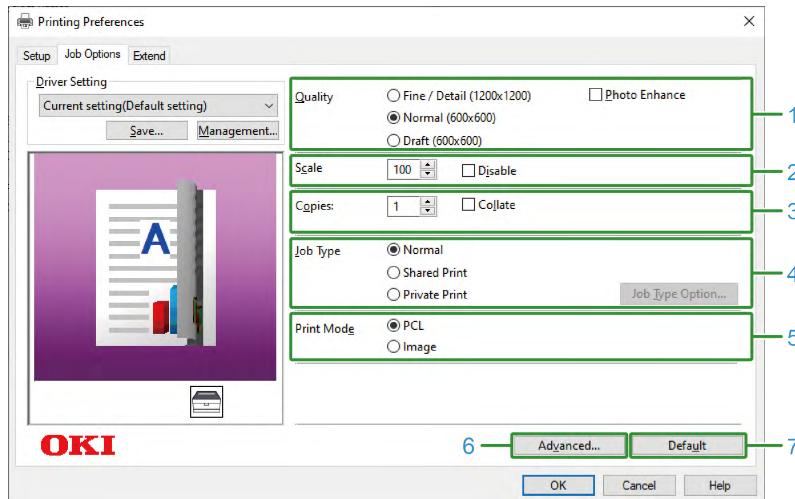

No.	Item	Description
1	Quality	Specifies the print resolution.
2	Scale	Sets the enlargement/reduction of printing.
3	Copies	Specifies the number of copies.
4	Job type	Sets the type of printing.
5	Print mode	Sets whether the print data sent to the printer is in PCL format or as an image.
6	Advanced	Make other printing settings.
7	Default	Restores the settings of each item in the tab to the initial values.

[Extend] tab

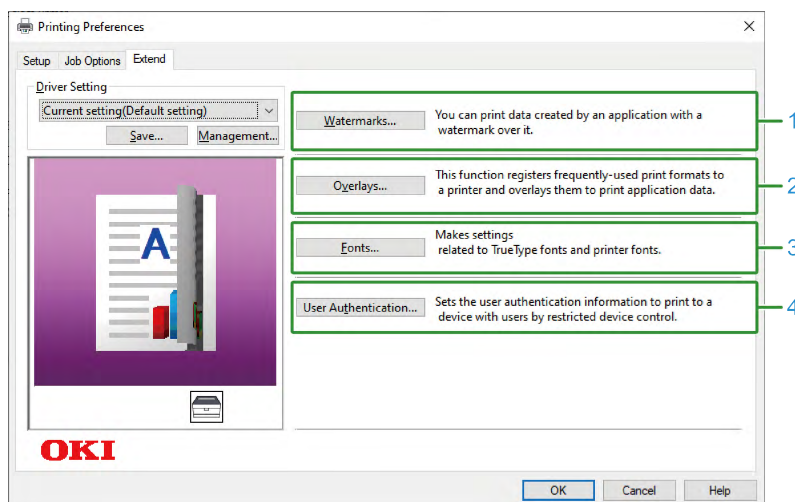

No.	Item	Description
1	Watermarks	Set for printing with a text or stamp watermark.
2	Overlays	Set for printing with an overlapping print format registered in the printer beforehand.
3	Fonts	Sets the TrueType font and printer font.
4	User authentication	Sets the user authentication.

Windows PS printer driver

[Layout] tab

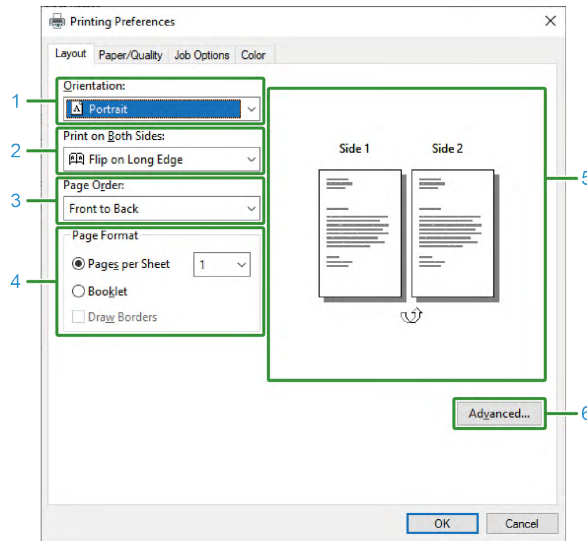

No.	Item	Description
1	Orientation	Sets the printing orientation.
2	Print on Both Sides	Set for duplex printing.
3	Page order	Sets the order of pages to be printed.
4	Page format	Specifies the number of pages to be printed on one sheet of paper and booklet printing.
5	Layout image	Displays a sample image of the print layout.
6	Advanced	You can make detail settings such as the print quality and media size.

[Paper/Quality] tab

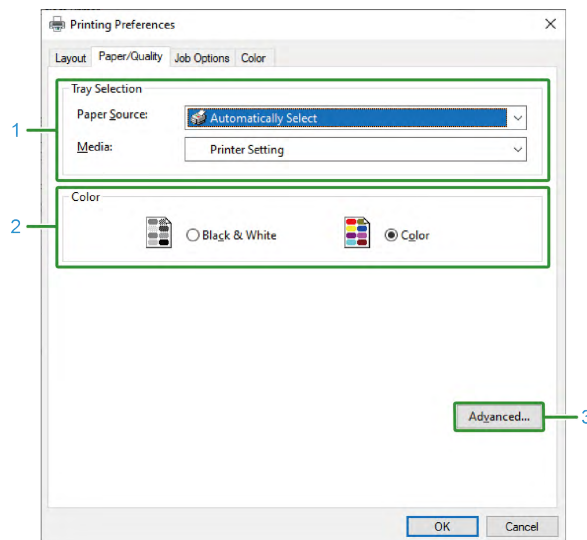

No.	Item	Description
1	Tray selection	Changes the paper tray.
2	Color	Selects to print in color/mono mode.
3	Advanced	You can make detail settings such as the print quality and media size.

[Job Options] tab

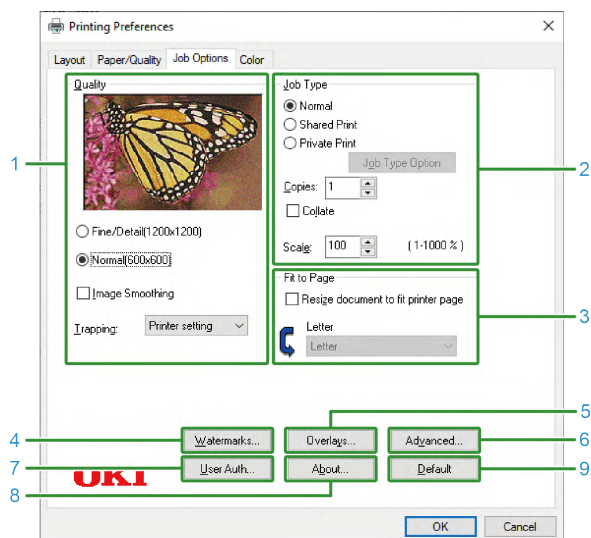

No.	Item	Description
1	Quality	Specifies the print resolution.
2	Job Type	Sets the type of print data and the number of copies. When [Shared Print] or [Private Print] is set, [Job Type Options] is available. If [Collate] is checked, multiple documents will be printed as a batch.
3	Fit to page	Check [Resize document to fit printer page] to print on a different size of paper.
4	Watermarks	Set for printing with a text or stamp watermark.
5	Overlays	Set for printing with an overlapping format registered in the printer beforehand.
6	Advanced	Other settings can be made.
7	User authentication	Sets the user authentication.
8	About	Displays the version of the printer driver.
9	Default	Restores the settings of each item in the tab to the initial values.

[Color] tab

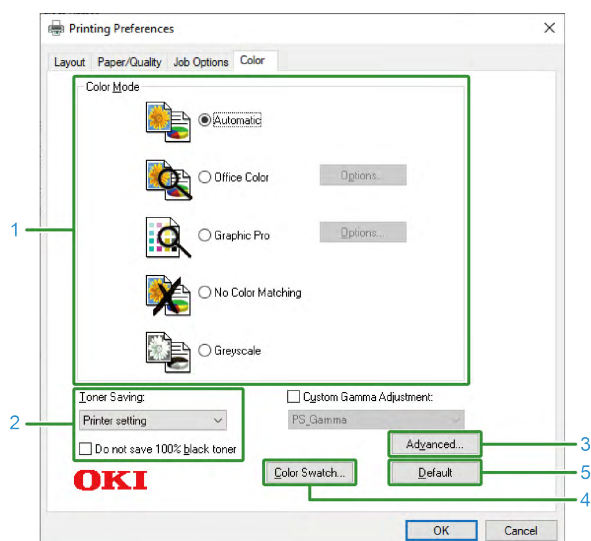

No.	Item	Description
1	Color Mode	Specifies the color adjustment for colored printing.
2	Toner Saving	Print in the toner save mode.
3	Advanced	Other printing settings can be made.
4	Color Swatch Utility	Starts the Color Swatch Utility.
5	Default	Restores the settings of each item in the tab to the initial values.

macOS printer driver

[Layout] panel

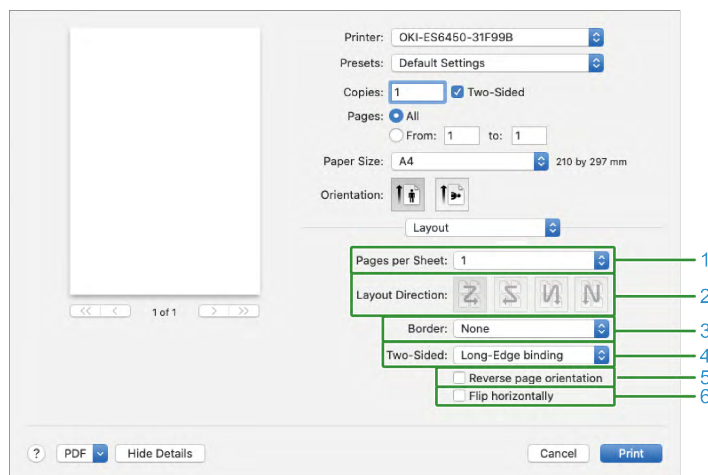

No.	Item	Description
1	Pages per Sheet	Selects the number of pages to be printed on one sheet of paper.
2	Layout direction	Specifies the layout for printing multiple pages on one sheet of paper.
3	Border	Specifies the type of borders.
4	Two-Sided	Specifies settings for printing on both sides.
5	Reverse page orientation	Checked to print with the page direction reversed.
6	Flip horizontally	Checked to print with the left and right reversed.

[Color Matching] panel

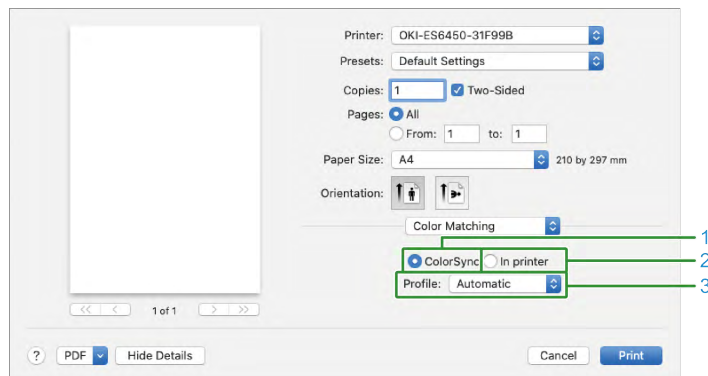

No.	Item	Description
1	ColorSync	Specifies the ColorSync function.
2	In printer	Uses color matching in this machine.
3	Profile	Specifies a profile.

[Paper Handling] panel

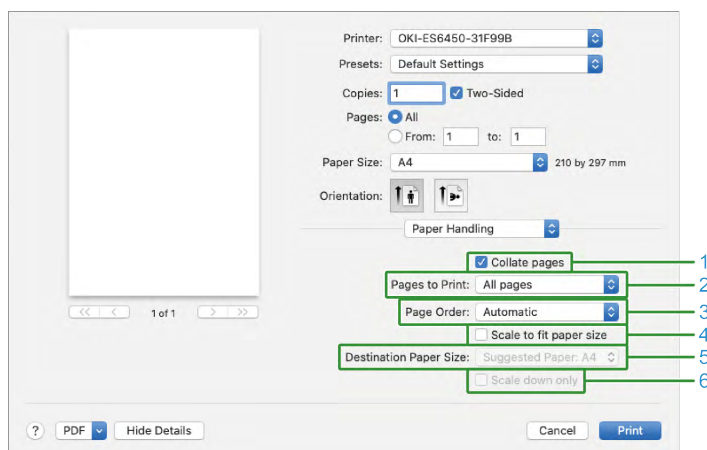

No.	Item	Description
1	Collate pages	Checked to print a multi-page document in collation.
2	Pages to print	Specifies the pages to be printed.
3	Page Order	Specifies the order of pages to be printed.
4	Scale to fit paper size	Prints by fitting to the media size. Depending on the settings, printing may not work correctly. Checked to print by zooming-in/-out according to the media size.
5	Destination Paper Size	Specifies the size of the paper to be printed when [Scale to fit paper size] is checked.
6	Scale down only	Specifies settings for printing in reduction only to fit the size of the paper.

[Paper Feed] panel

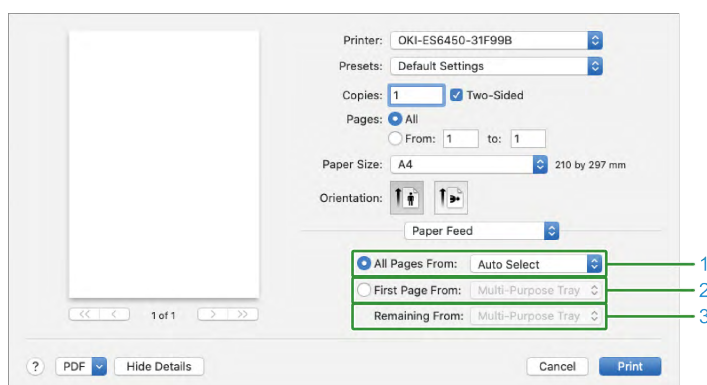

No.	Item	Description
1	All Pages From	Specifies the tray to feed paper. When [Auto Select] is specified, a tray is selected automatically.
2	First Page From	Selected to print only the first page from the specified tray.
3	Remaining From	Selected to print the remaining pages from the specified tray.

[Cover Page] panel

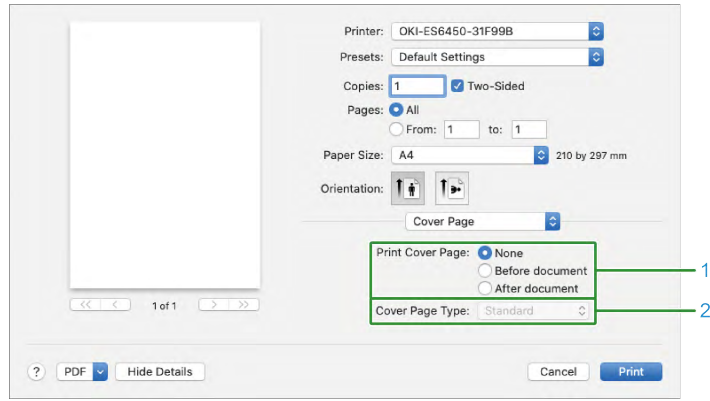

No.	Item	Description
1	Print Cover Page	Specifies the cover printing.
2	Cover Page Type	Specifies the text string for cover printing.

[Color] panel

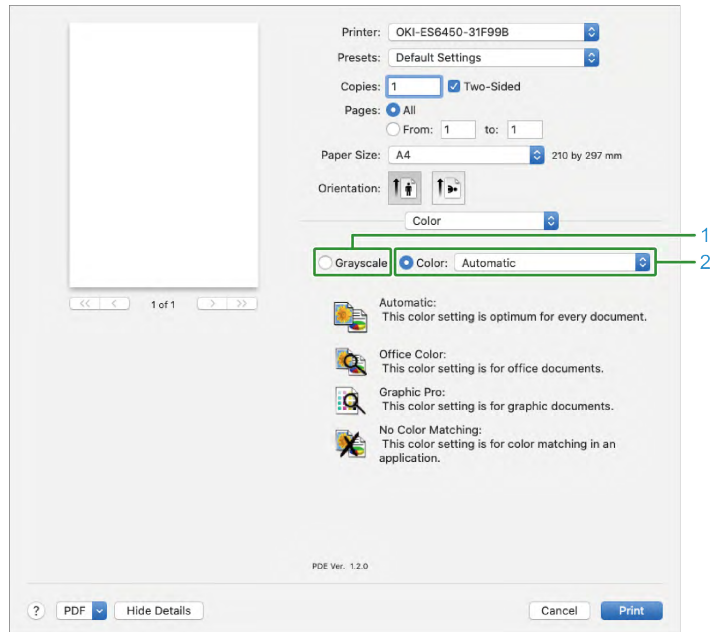

No.	Item	Description
1	Grayscale	Print in monochrome.
2	Color	Specifies the color adjustment for colored printing.

[Print Options] panel

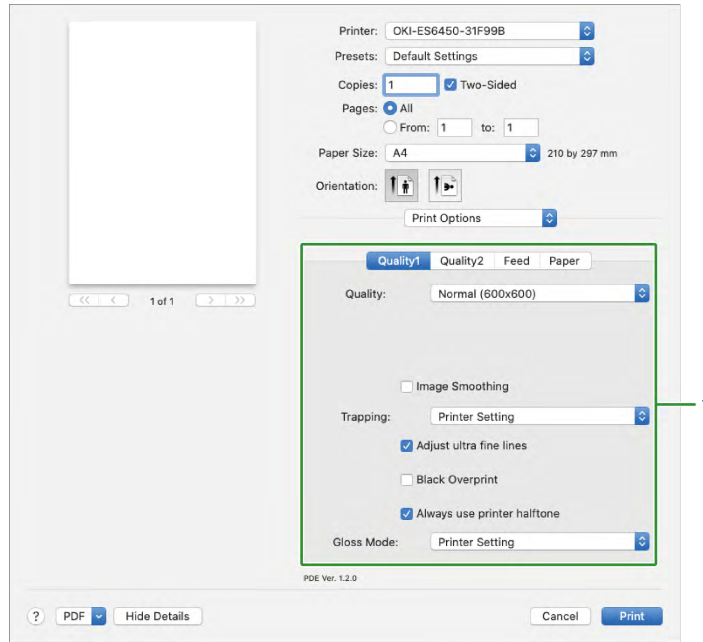

No.	Item	Description
1	Quality1, Quality2, Feed, Paper	Specifies the print quality, toner save, media type, etc.

[User Authentication] panel

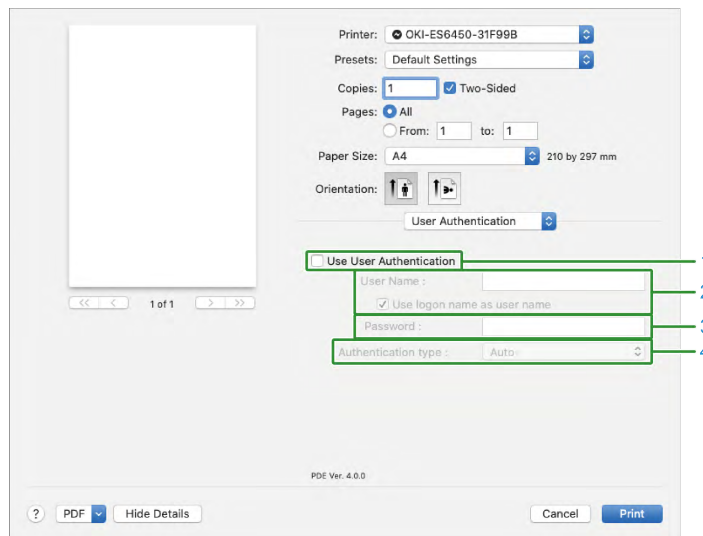

No.	Item	Description
1	Use user authentication	Checked to set user authentication for printing.
2	User name	The user name for user authentication.
3	Password	The password for user authentication.
4	Authentication type	Specifies the authentication type to be used.



- [Authentication Type] can be enabled in the [Options] tab of [Options and Supplies] displayed by selecting [System Preferences] - [Printers and Scanners] from the Apple menu.

[Secure Print] panel

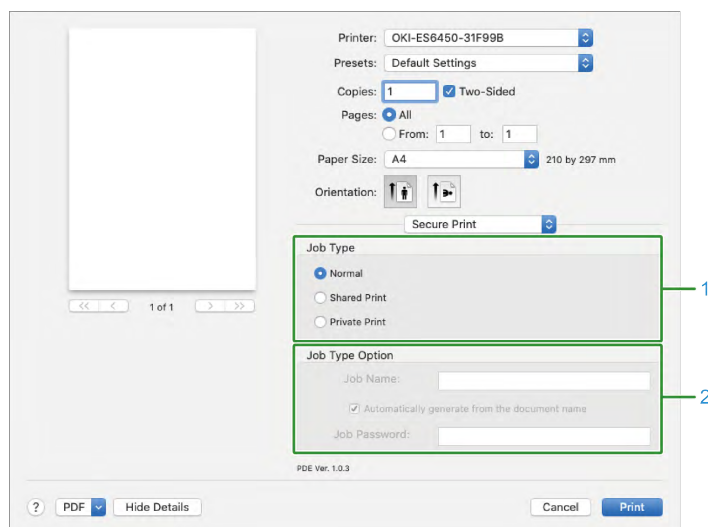

No.	Item	Description
1	Job Type	Specifies the type of print data. When [Private Print] or [Shared Print] is set, [Job Type Options] is available.
2	Job Type Options	Specifies the password for printing the job name displayed on the panel.

[Supply Level] panel

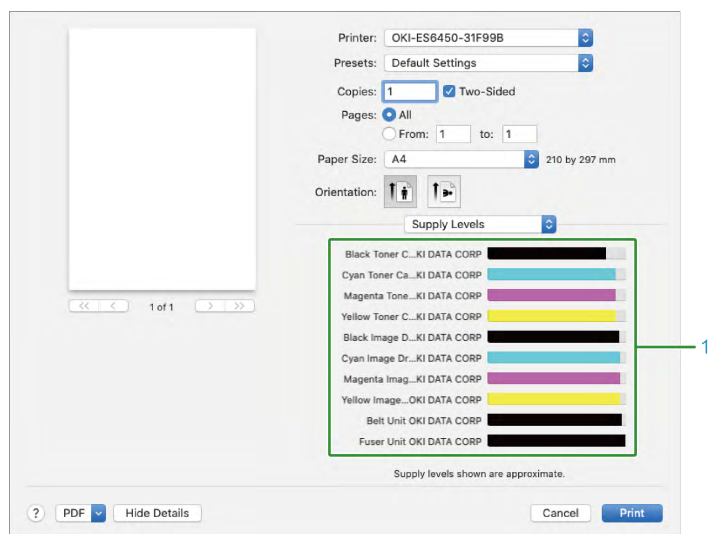

No.	Item	Description
1	Consumables	Displays the usage status of consumables.



- The [Supply Level] panel may not be displayed depending on the usage environment such as the connection method of this machine.

How to open the printer folder

This section explains how to open the printer driver icon folder for each version of Windows.

For Windows 10 (Version 1703 or later)/Windows Server 2019

- 1 Click [Start] to display the application list.
- 2 Select [Windows System Tool] - [Control Panel] - [Devices and Printers].

For Windows Server 2012 R2/Windows Server 2016

- 1 Select [Control Panel] - [View devices and printers].

For Windows 10/Windows 8/Windows 8.1/Windows Server 2012

- 1 Open the control panel and select [View devices and printers].

For Windows 7/Windows Server 2008 R2

- 1 Select [Start] - [Devices and Printers].

6

Management of this machine

Admin password..... 114

Admin password

The admin password is used to change the settings of the machine.

We recommend you to change the admin password to protect your personal information.

Checking the factory default admin passwords

The factory default admin password is set to a 10-digit value of this machine's serial number with upper-case letters converted to lower-case ones.

Examples of serial number and admin password

Item	Example	Value checked by customer
Serial number	AB01234567	
Admin password	ab01234567	



- The serial number may be displayed as [Serial Number] or [Serial No.].

Check the machine's serial number with one of the following methods.

- Check by the display on the operator panel.
- Check by printing the menu map.
- Check against the sticker inside the machine.

This section explains the procedure assuming that the machine's serial number is "AB01234567".

Checking by the display on the operator panel



- On the operator panel, the serial number is displayed as [Serial Number].

- Press the scroll button ▼ on the operator panel several times to select [Configuration], and press «OK».

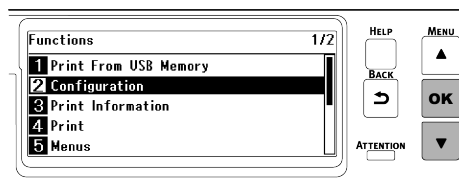

- Press ▼ or ▲ several times to select [System], and press «OK».

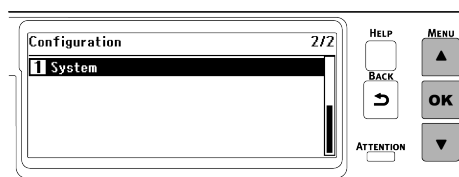

- 3 Check that [Serial Number] is selected, and press «OK».

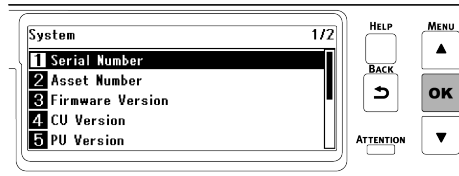

- 4 Check the 10-digit alphanumeric characters displayed in [Serial Number].

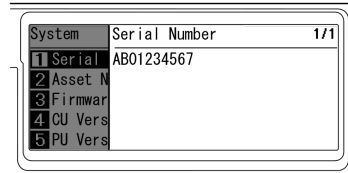

- 5 Convert the upper-case letters of [Serial Number] into lower-case ones and use the converted string as the admin password.

Checking by printing the menu map



- On the menu map, the serial number is displayed as [Serial Number].

- 1 Print the menu map.

[Printing the menu map \(configuration\)\(P.84\)](#)

- 2 Check [Serial Number].

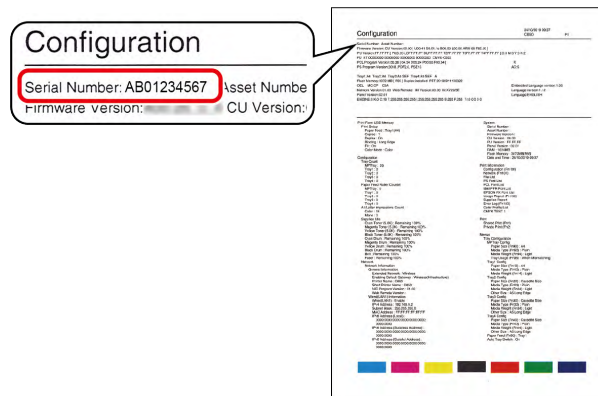

- 3 Convert the upper-case letters of [Serial Number] into lower-case ones and use the converted string as the admin password.

Checking against the sticker inside the machine

- 1 Pull the front cover open lever (blue) to open the front cover.

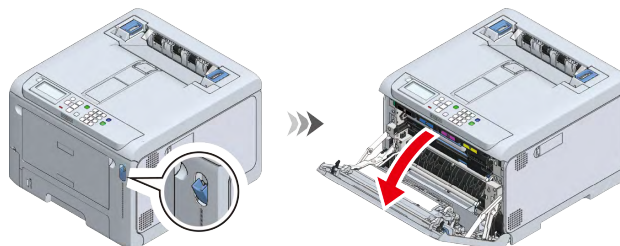

- Check the leftmost 10 digits of the alphanumeric characters written on the sticker on the left to the L2 lever.

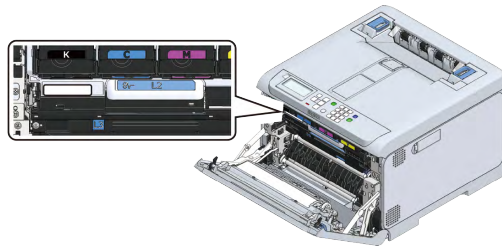

- You may convert the upper-case letters into lower-case ones and use the converted string as the admin password.

Inputting the factory default admin passwords

This section explains the procedure assuming that the factory default admin password is "ab01234567".

 [Checking the factory default admin passwords\(P.114\)](#)

- Check that "Ready To Print" appears on the display.



- If the machine is in the power save mode, press «POWER SAVE» to restore.

- Press the scroll button ▼ on the operator panel several times to select [Admin Setup], and press «OK».
- Press «2» twice using the numeric keypad to confirm that "a" is displayed, and press «OK». The entered character is displayed in "*" and the cursor moves to the next position.

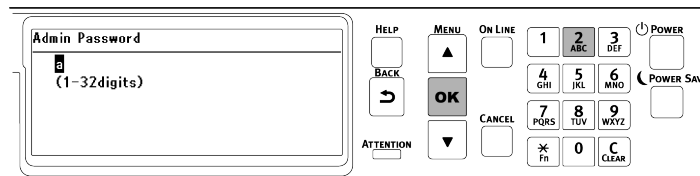

- Press «2» for three times to confirm that "b" is displayed, and press «OK».

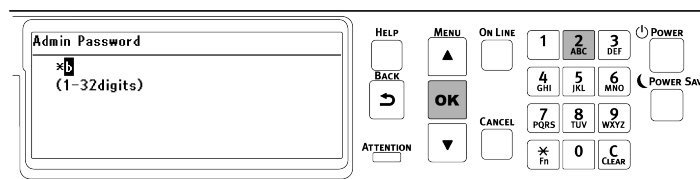

- Press «0» and then «OK».

- Press «1».



- It is not necessary to press «OK» since «1» is confirmed by one press.

- Press «2» and then «OK».

- Input the remaining characters by the same procedure.

- 9 Press «OK» again to complete inputting the admin password and display [Admin Setup].

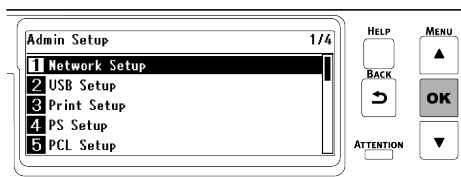

Changing the admin password

The admin password can consist of 1 to 32 digits.

The following characters can be used for the admin password.

- Upper-case letters
- Lower-case letters
- Figures
- Symbols: [Space] ! " # \$ % & ' () * + , - . / : ; < = > ? @ [¥] ^ _ ` { | } ~



- Be sure to write down the password you set just in case you forget.
- If you forget the changed password, you cannot change [Admin Setup] or [Boot Menu].
- If you wish to reset the password, the charged service by maintenance staff will be necessary.



- If the machine is in the power save mode, press «POWER SAVE» to restore.

This section describes how to change the factory default admin password as an example.

- 1 Check that "Ready To Print" appears on the display.



- If the machine is in the power save mode, press «POWER SAVE» to restore.

- 2 Press the scroll button ▼ on the operator panel several times to select [Admin Setup], and press «OK».

- 3 Input the factory default admin password.

[Inputting the factory default admin passwords\(P.116\)](#)

- 4 Press the scroll button ▲ or ▼ on the operator panel several times to select [Change Password], and press «OK».

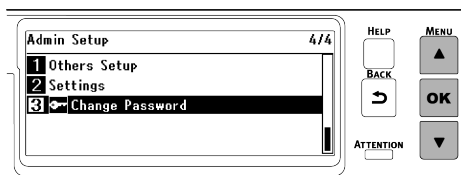

- 5 Enter a new password and press «OK».

[Inputting text\(P.91\)](#)

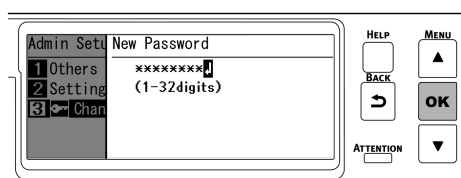

6 Press «OK» again to display the [Verify Password] screen.

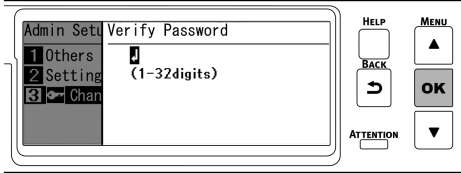

7 Input the password again, and press «OK».

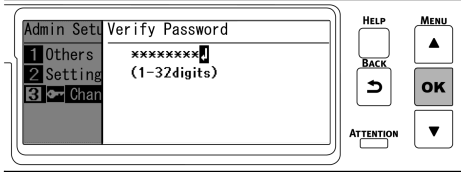

8 When «OK» is pressed again, the password has been changed and the screen returns to [Admin Setup].

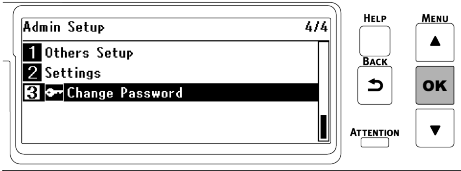

Admin password memo field	
---------------------------	--





7 Maintenance











Precautions for replacing consumables	120
Service life and replacement cycle of consumables	121
Replacing the black(K) toner cartridge and the waste toner box	123
Replacing the toner cartridge (C/M/Y).....	126
Replacing the image drum	128
Service life and replacement cycle of maintenance parts.....	131
Replacing the belt unit.....	133
Replacing the fuser unit	135
Cleaning the main unit and the parts	137

This section explains how to maintain this machine for a long and comfortable use.

Precautions for replacing consumables

Note the following points during the replacement.

 WARNING	
	Do not throw the toner, toner cartridge or waste toner box into fire. Toner may fly off, thus causing burns.
	Do not store the toner cartridge and waste toner box in a place with fire. Doing so may cause a fire or burns.
	Do not clean up spilled toner using an electric vacuum cleaner. When spilled toner is cleaned up using an electric vacuum cleaner, a fire may be caused due to sparks from electrical contacts. Wipe off and remove the toner spilled on the floor using a wet cloth.
	As the fuser unit may be hot, be cautious during operation and always hold the handle to lift it. When it is hot, wait until it cools down before any operation.

 CAUTION	
	There are high-temperature parts inside the machine. Do not touch the area with the "Caution: High Temperature" label. Doing so may cause burns.
	Keep the toner cartridge and waste toner box out of the reach of children. If children swallow toner by mistake, immediately consult a physician.
	When toner is inhaled, gargle with a lot of water and move the person to a place with fresh air. Consult a physician as necessary.
	When toner gets contact with the skin of your hands etc., wash it off with soapy water.
	If toner gets into your eyes, immediately wash it off with a large quantity of water. Consult a physician as necessary.
	When toner is swallowed, exhale the toner. Consult a physician as necessary.
	When clearing a paper jam or replacing the toner cartridge and the waste toner box, take care that your hands and clothes are not stained with toner. When clothes are stained with toner, wash them in cold water. Heating it like washing in hot water may dye the toner on clothes, and the stains may not be removed easily.
	Do not disassemble the image drum, toner cartridge, waste toner box or belt unit. Doing so may scatter the toner, which may be inhaled by people or may stain clothes or hands.
	Store the used toner cartridge and the waste toner box in a bag so that toner does not scatter.



- Use genuine OKI consumables for optimum performance.
- Failures caused by using non-genuine consumables may void the warranty or maintenance contract. (The use of non-genuine consumables will not necessarily cause failures, but please fully take notice of such usage.)

Service life and replacement cycle of consumables

Toner cartridge

Service life of the toner cartridge

To check the remaining toner amount, select the toner of each color in [Configuration] - [Supplies Status] from the operator panel.

Replacement cycle of the toner cartridge

When the time for replacement is approaching or has arrived, the following message appears on the display.

	<u>When the time for replacement is approaching</u>	→	<u>When the time for replacement has arrived</u>
Displayed message	Cyan/Magenta/Yellow/Black (K) Toner Low.	→	Cyan/Magenta/Yellow/Black (K) Toner Is Empty. Replace With A New Toner Cartridge.
Response to the message	Prepare a new toner cartridge of the displayed color.	→	Replace the toner cartridge with a new one.
State of this machine	Printing is possible, but the toner of the displayed color is low.	→	The toner of the displayed color is empty. Printing stops.

About 200 pages can be printed from when the time for replacement is approaching to when the time for replacement has arrived. (This is the reference value in the case of A4 simplex printing with a density of 5%.)



- Printing quality will decline after the toner cartridge stays unpacked for one year or longer. Therefore, prepare a new toner cartridge.
- Use genuine OKI consumables for optimum performance.
- Failures caused by using non-genuine consumables may void the warranty or maintenance contract. (The use of non-genuine consumables will not necessarily cause failures, but please fully take notice of such usage.)
- Printing under the following conditions may damage the image drum. Replace the toner cartridge immediately.
 - Opening and closing the front cover with toner empty
 - Printing in mono without cyan (blue), magenta (red) or yellow (yellow) toner
- Replace the toner cartridge immediately when a message indicating replacement of the toner cartridge is displayed and printing has stopped.
- If you repeatedly open and close the front cover so that you can continue printing temporarily, a failure may be caused or the print quality may be degraded.
In addition, after a certain period of time, printing will be disabled even if you open and close the front cover. (The printable period of time varies with the usage condition.)

 [Replacing the black\(K\) toner cartridge and the waste toner box\(P.123\)](#)

 [Replacing the toner cartridge \(C/M/Y\)\(P.126\)](#)

Image drum

Service life of the image drum

The image drum can print approximately 50,000 sheets of A4-sized paper (for simplex printing), but the actual printable number of sheets may vary with the usage condition.

The above number is based on the general usage condition (three sheets at a time). If you print a single sheet at a time, the life may be reduced by half. A message appears indicating preparation for replacement when the end of life is approaching.

To check the life of the image drum, select the image drum of each color in [Configuration] - [Supplies Status] from the operator panel.

Replacement cycle of the image drum

When the time for replacement is approaching or has arrived, the following message appears on the display.

	<u>When the time for replacement is approaching</u>	→	<u>When the time for replacement has arrived</u>
Displayed message	Cyan/Magenta/Yellow/Black (K) Image Drum Near Life.	→	Cyan/Magenta/Yellow/Black (K) Image Drum End Of Life. Replace With A New [Color Name] Image Drum
Response to the message	Prepare a new image drum of the displayed color.	→	Replace the image drum with a new one.
State of this machine	Printing is possible, but the image drum of the displayed color is approaching the end of its service life.	→	The image drum of the displayed color has reached the end of its service life. Printing stops.

About 1,500 pages can be printed from when the time for replacement is approaching to when the time for replacement has arrived.



- Printing quality will decline after the image drum stays unpacked for one year or longer. Therefore, prepare a new image drum.
- Because the image drum (green part) can easily get damaged, handle with adequate care.
- Do not expose the image drum to direct sunlight or strong light (About 1,500 lux or above). Do not leave it uncovered for more than 5 minutes even under room lighting.
- Use genuine OKI consumables for optimum performance.
- Failures caused by using non-genuine consumables may void the warranty or maintenance contract. (The use of non-genuine consumables will not necessarily cause failures, but please fully take notice of such usage.)
- Replace the image drum immediately when a message indicating replacement of the image drum is displayed and printing has stopped.

If you repeatedly open and close the front cover so that you can continue printing temporarily, a failure may be caused or the print quality may be degraded.

In addition, after a certain period of time, printing will be disabled even if you open and close the front cover. (The printable period of time varies with the usage condition.)

- If [Admin Setup] - [Panel Setup] - [Near Life Status] is set to [Disable], a message indicating the time for replacement will not be displayed.



- You can change the timing for displaying a message indicating the time for replacement of the image drum. The factory default value is [1500].
This timing can be set from [Admin Setup] - [Others Setup] - [Near Life Setup] - [Drum Near Life Timing] on the operator panel.
The setting range is from 500 to 5,000 (in increments of 500).

[Replacing the image drum](#)(P.128)

Replacing the black(K) toner cartridge and the waste toner box

The black(K) toner cartridge comes with a waste toner box.

By following on-screen instructions, replace the waste toner box first and then the black(K) toner cartridge.

- 1 Press the knob on the lower left corner on the front of the machine, and open the waste toner box cover toward you.

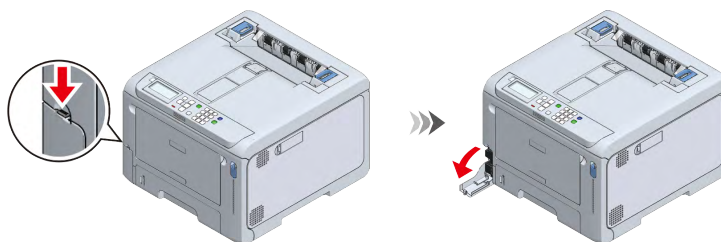

- 2 Put your finger on the recess of the waste toner box, pull it out halfway, and pull it out by the top.

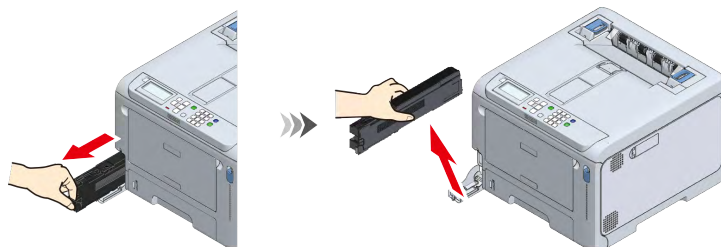

- 3 Prepare a new waste toner box.



- 4 Install the new waste toner box into this machine.

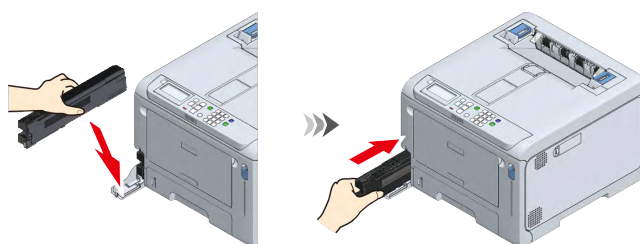

- 5 Close the cover of the waste toner box.

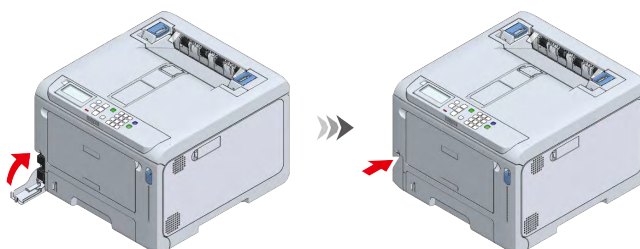

- 6** Take the new black(K) toner cartridge out of its packing box.



- 7** Shake the new toner cartridge both horizontally and vertically for several times.



- 8** Pull the front cover open lever (blue) to open the front cover.

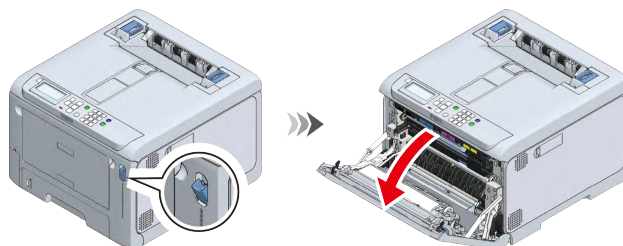

- 9** Pull out the black(K) toner cartridge from the machine.

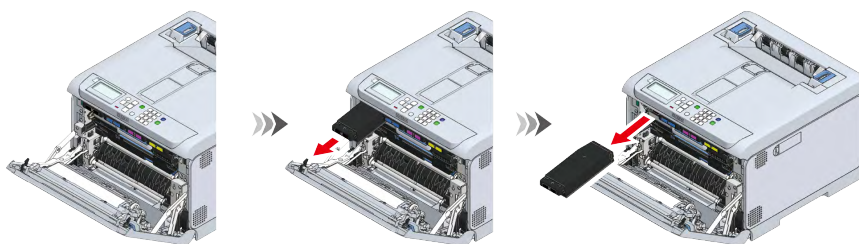

- 10** Install the new black(K) toner cartridge into the machine.

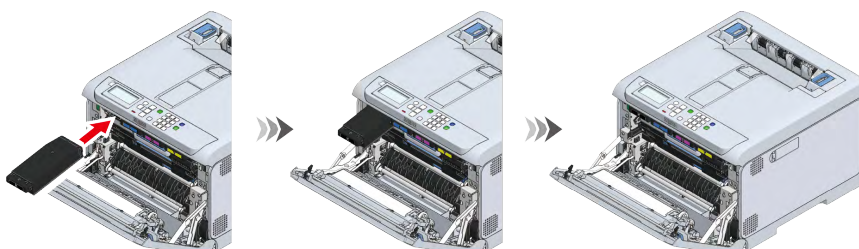

- 11** Close the front cover firmly with both hands.

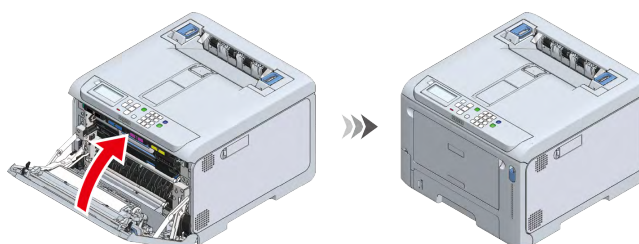

12 Press «OK».

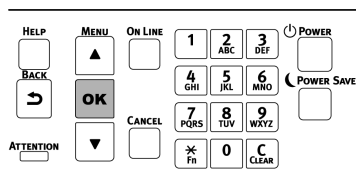

13 Check that no error message appears on the display.



- Please recycle the used toner cartridge and waste toner box.

Replacing the toner cartridge (C/M/Y)

This section takes the toner cartridge (M) as an example. The toner cartridge (C/Y) can be replaced by the same procedure.



- To replace the black toner cartridge (K), please refer to "[Replacing the black\(K\) toner cartridge and the waste toner box\(P.123\)](#)".

- 1 Remove the new toner cartridge of the color to be replaced from its packing case.



- 2 Shake the new toner cartridge both horizontally and vertically for several times.



- 3 Pull the front cover open lever (blue) to open the front cover.

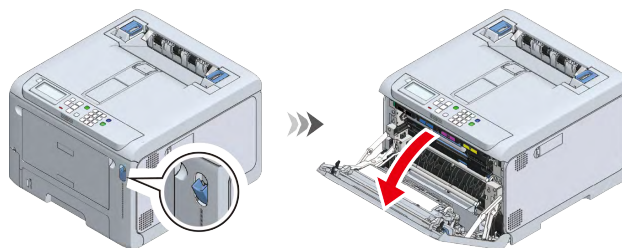

- 4 Remove the toner cartridge of the color to be replaced from the machine.



- 5 Insert the new toner cartridge into the machine.

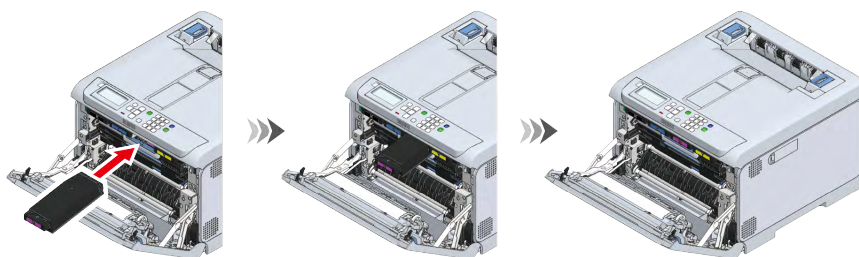

- 6 Close the front cover firmly with your both hands.

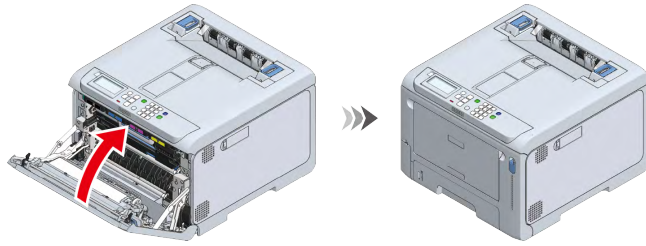

- Please recycle the used toner cartridge.

Replacing the image drum

- 1 Pull the front cover open lever (blue) to open the front cover.

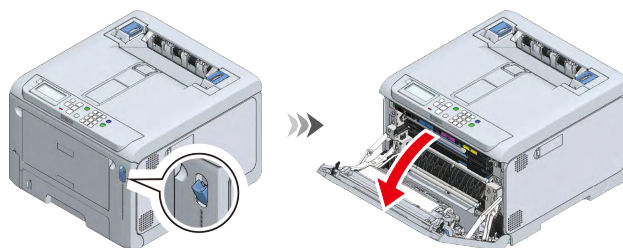

- 2 Pull the L1 lever towards you until the red triangle mark on the L1 lever is aligned with the red triangle mark inside the machine.



- If the two red triangle marks are not aligned correctly, you cannot proceed to the procedure of replacing the image drum.

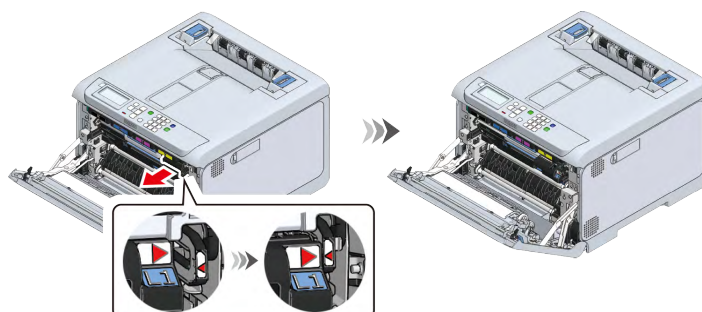

- 3 Pull the L2 lever and lift the output tray to the stop position.



- The image drum basket cannot be pulled out unless the output tray is fully open.

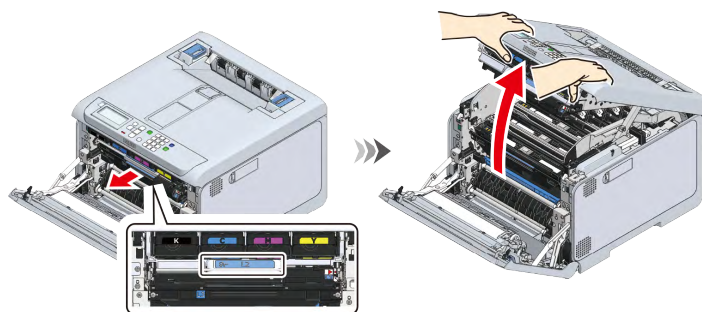

- 4 Hold the L3 handle and pull out the image drum basket until it stops.

CAUTION

Doing so may cause burns.



Do not touch the fuser unit because it is hot.

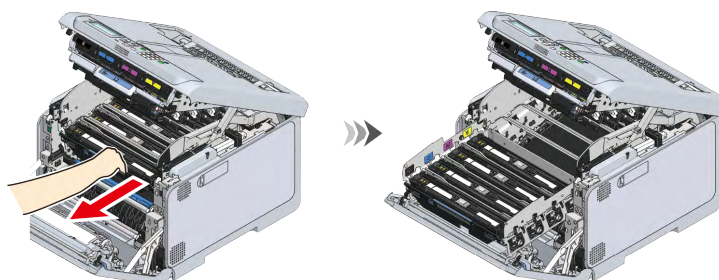

- 5 Check the image drum to be replaced by the label color.

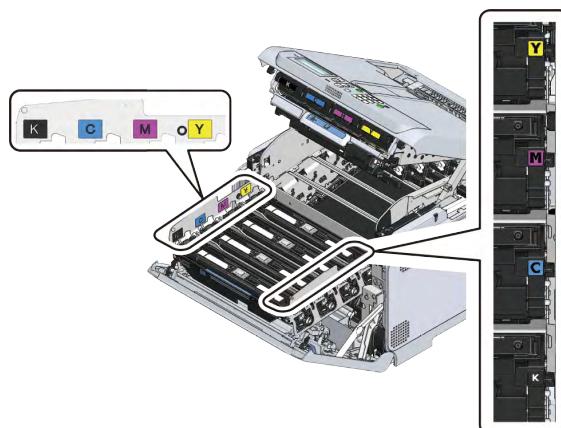

- 6 Remove the image drum of the color to be replaced.



- Because image drums (green parts) can easily get damaged, handle with adequate care.
- Do not expose the image drum to direct sunlight or strong light (About 1,500 lux or above). Do not leave it uncovered for more than 5 minutes even under room lighting.



- The image drum is not fixed in the main unit. You can just lift to remove it.

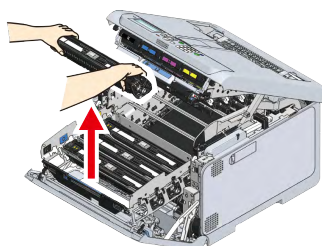

- 7 Take the new image drum of the color to be replaced out of its box.

- 8 Take out the desiccant of the new image drum.



- 9 Install the new image drum in this machine by holding it with the color label on the right.



- Because image drums (green parts) can easily get damaged, handle with adequate care.
- Do not expose the image drum to direct sunlight or strong light (About 1,500 lux or above). Do not leave it uncovered for more than 5 minutes even under room lighting.

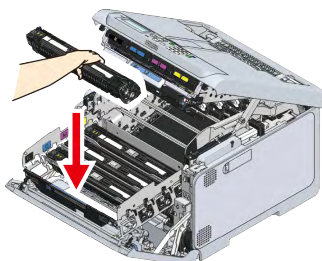

10 Hold the L3 handle and push the image drum basket all the way in.

- If the image drum is not installed correctly, the image drum basket cannot be pushed all the way in.
- The output tray cannot be closed unless the image drum basket is pushed all the way in.

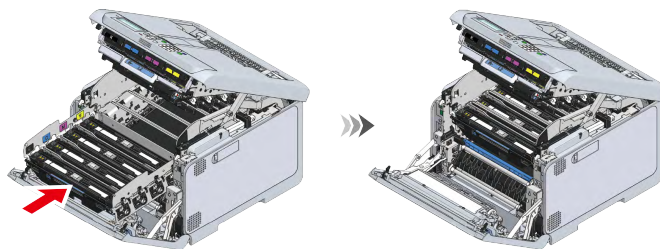
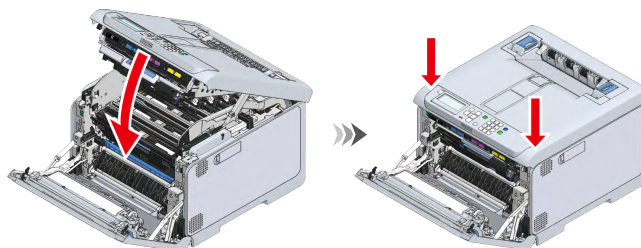
**11** Close the output tray, and push both sides down from top.**12** Press the L1 lever all the way in.

- The front cover cannot be closed unless all the image drums of the four colors are installed.

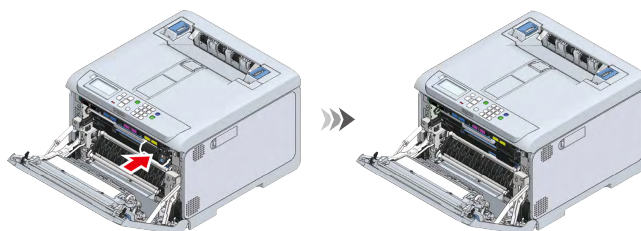
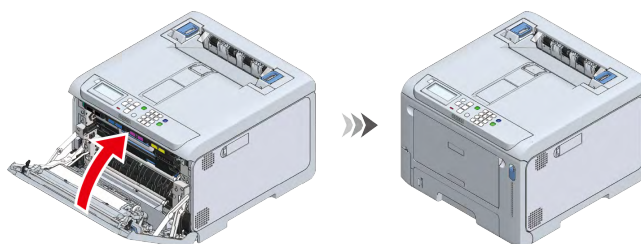
**13** Close the front cover firmly with both hands.

- Please recycle the used image drum.

Service life and replacement cycle of maintenance parts

Belt unit

Service life of the belt unit

The belt unit can print approximately 60,000 sheets of A4-sized paper (for simplex printing), but the actual printable number of sheets may vary with the usage condition.

The above number is based on the general usage condition (three sheets at a time).

To check the life of the belt unit, select [Functions] - [Configuration] - [Supplies Status] - [Belt] from the operator panel.

Replacement cycle of the belt unit

When the time for replacement is approaching or has arrived, the following message appears on the display.

	<u>When the time for replacement is approaching</u>	→	<u>When the time for replacement has arrived</u>
Displayed message	Belt Unit Near Life.	→	Belt Unit End Of Life. Replace With A New Belt Unit.
Response to the message	Please prepare a new belt unit.	→	Replace the belt unit with a new one.
State of this machine	Printing is possible, but the belt unit is approaching the end of its service life.	→	The belt unit has reached the end of its service life. Printing stops.

About 1,500 pages can be printed from when the time for replacement is approaching to when the time for replacement has arrived.



- A message indicating replacement of the belt unit may be displayed without displaying a message indicating that the time for replacement is approaching.
In this case, please replace the belt unit.
- Replace the belt unit immediately when a message indicating replacement of the belt unit is displayed and printing has stopped.
If you repeatedly open and close the front cover so that you can continue printing temporarily, a failure may be caused or the print quality may be degraded.
In addition, after a certain period of time, printing will be disabled even if you open and close the front cover. (The printable period of time varies with the usage condition.)
- If [Admin Setup] - [Panel Setup] - [Near Life Status] is set to [Disable], a message indicating the time for replacement will not be displayed.
- Because the image drum (green part) can easily get damaged, handle with adequate care.
- Do not expose the image drum to direct sunlight or strong light (About 1,500 lux or above). Do not leave it uncovered for more than 5 minutes even under room lighting.



- You can change the timing for displaying a message indicating the time for replacement of the belt unit. The factory default value is [1500].
This timing is set from [Admin Setup] - [Others Setup] - [Near Life Setup] - [Belt Near Life Timing] on the operator panel.
The setting range is from 500 to 5,000 (in increments of 500).

[Replacing the belt unit\(P.133\)](#)

Fuser unit

Service life of the fuser unit

The fuser unit can print approximately 60,000 sheets of A4-sized paper (for simplex printing), but the actual printable number of sheets may vary with the usage condition.

The above number is based on the general usage condition (three sheets at a time). If you print a single sheet at a time, the life may be reduced by half. A message appears indicating preparation for replacement when the end of life is approaching.

To check the life of the fuser unit, select [Functions] - [Configuration] - [Supplies Status] - [Fuser] from the operator panel.

Replacement cycle of the fuser unit

When the time for replacement is approaching or has arrived, the following message appears on the display.

	<u>When the time for replacement is approaching</u>	→	<u>When the time for replacement has arrived</u>
Displayed message	Fuser Near Life.	→	Fuser Unit End Of Life. Replace With A New Fuser Unit
Response to the message	Prepare a new fuser.	→	Replace With A New Fuser Unit.
State of this machine	Printing is possible, but the fuser unit is approaching the end of its service life.	→	Printing stops.

About 1,500 pages can be printed from when the time for replacement is approaching to when the time for replacement has arrived.



- Replace the fuser unit immediately when a message indicating replacement of the fuser unit is displayed and printing has stopped.
If you repeatedly open and close the front cover so that you can continue printing temporarily, a failure may be caused or the print quality may be degraded.
In addition, after a certain period of time, printing will be disabled even if you open and close the front cover. (The printable period of time varies with the usage condition.)
- If [Admin Setup] - [Panel Setup] - [Near Life Status] is set to [Disable], a message indicating the time for replacement will not be displayed.



- You can change the timing for displaying a message indicating the time for replacement of the fuser unit. The factory default value is [1500].
This timing is set from [Admin Setup] - [Others Setup] - [Near Life Setup] - [Fuser Near Life Timing] on the operator panel.
The setting range is from 500 to 5,000 (in increments of 500).

[Replacing the fuser unit\(P.135\)](#)

Replacing the belt unit

For the replacement cycle, see "Belt unit(P.131)".

- 1 Pull the front cover open lever (blue) to open the front cover.

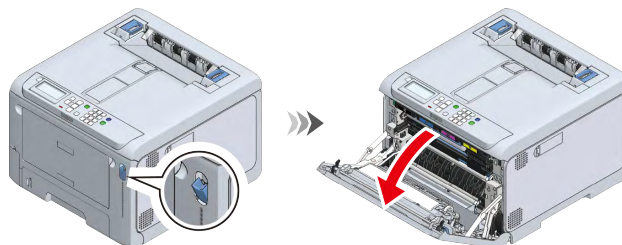

- 2 Pull the L2 lever and lift the output tray to the stop position.

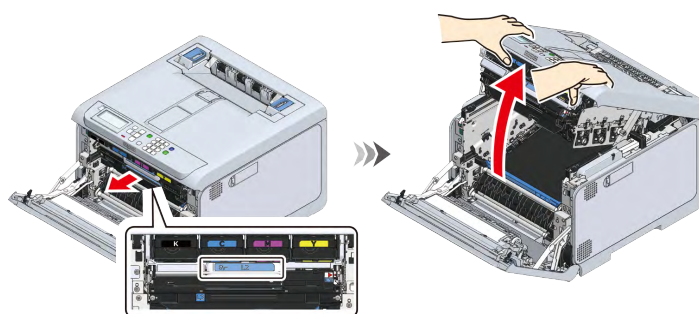

- 3 Remove the belt unit by holding its blue handle.

CAUTION

Doing so may cause burns.



Do not touch the fuser unit because it is hot.



- Because image drums (green parts) can easily get damaged, handle with adequate care.
- Do not expose the image drum to direct sunlight or strong light (About 1,500 lux or above). Do not leave it uncovered for more than 5 minutes even under room lighting.

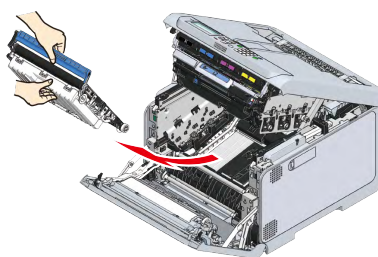

- 4 Take the new belt unit out of its box.

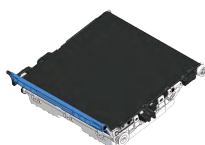

5 Install the belt unit in this machine by holding its blue handle.

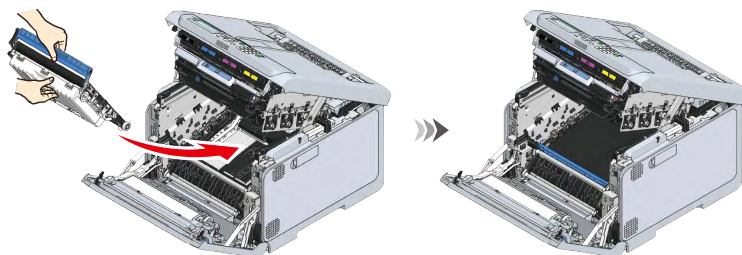

6 Close the output tray, and push both sides down firmly from top.

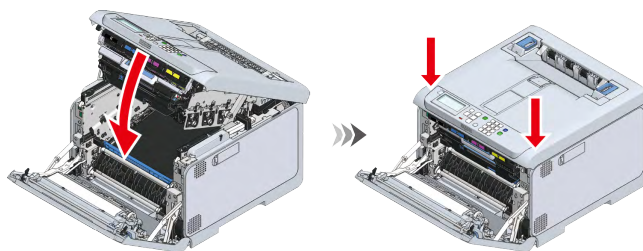

7 Close the front cover firmly with both hands.

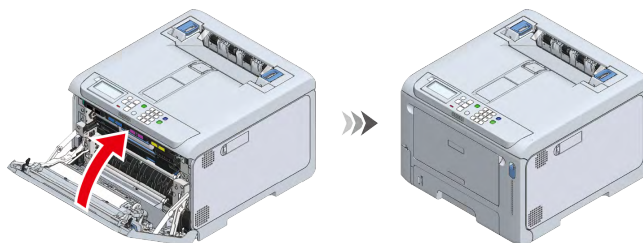

- Please recycle the used belt unit.

Replacing the fuser unit

For the replacement cycle, see "Fuser unit(P.132)".

- 1 Lift the left and right handles of the fuser unit at the back of the output tray until a click is heard, and then release the lock.



- The fuser unit cannot be removed unless its handle is raised vertically.

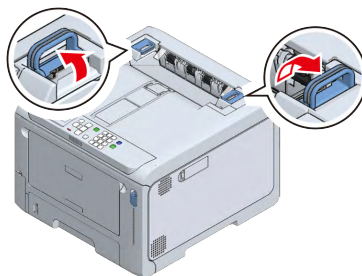

- 2 Remove the fuser unit from this machine by holding its left and right handles.



CAUTION

Doing so may cause burns.



When the fuser unit is hot, wait until it cools down before any operation.



- Do not expose this machine with the fuser unit removed to direct sunlight or strong light (About 1,500 lux or above). Do not leave it uncovered for more than 5 minutes even under room lighting.

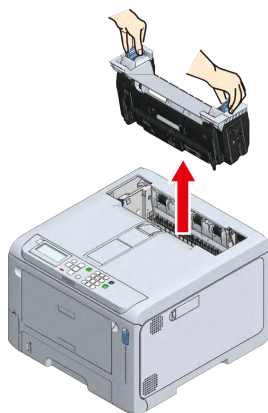

- 3 Take the new fuser unit out of its box, and lift the left and right handles up vertically until a click is heard.

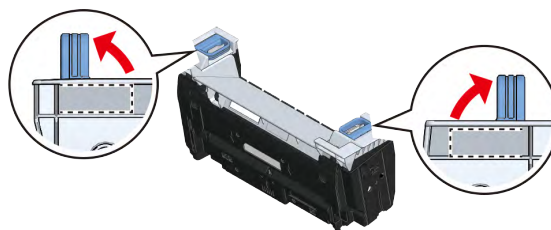

- 4 With the warning label of the new fuser unit facing the front, hold both the left and right handles and install the fuser unit into this machine.

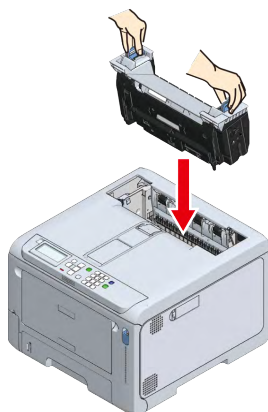

- 5 Push down the left and right handles of the fuser unit to lock.



- Make sure that the fuser unit does not float from the top of the output tray. If floating, the fuser unit will not be recognized so that it is not possible to start printing.

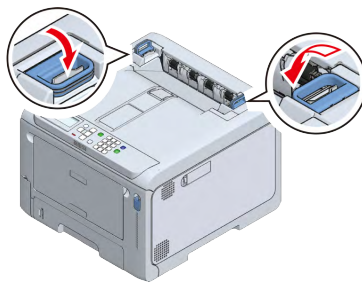

- Please recycle the used fuser unit.

Cleaning the main unit and the parts

Cleaning the LED head

If there are white stripes on the output paper, the image is faded or the text is blurred, clean the LED head.



- Do not use methyl alcohol or thinner. Doing so may damage the LED head.
- Do not expose the image drum to direct sunlight or strong light (About 1,500 lux or above). Do not leave it uncovered for more than 5 minutes even under room lighting.

1 Power off this machine.

2 Pull the front cover open lever (blue) to open the front cover.

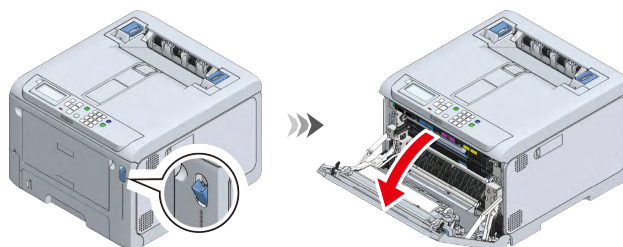

3 Pull the L1 lever towards you until the red triangle mark on the L1 lever is aligned with the red triangle mark inside the machine.



- If the two red triangle marks are not aligned correctly, you cannot separate the output tray and the image drum basket.

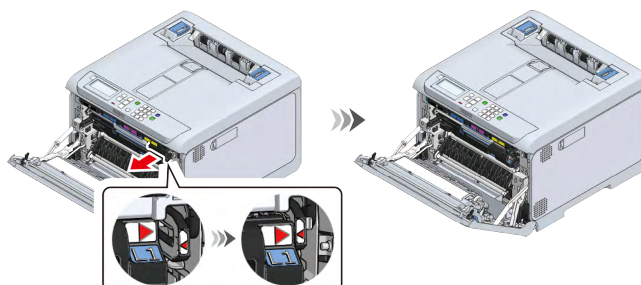

4 Pull the L2 lever and lift the output tray to the stop position.

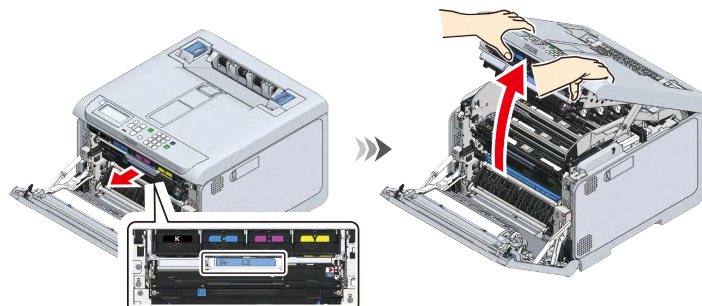

5 Gently wipe the lens surface of the LED head (x 4) with a soft tissue paper.



- Do not expose the image drum to direct sunlight or strong light (About 1,500 lux or above). Do not leave it uncovered for more than 5 minutes even under room lighting.

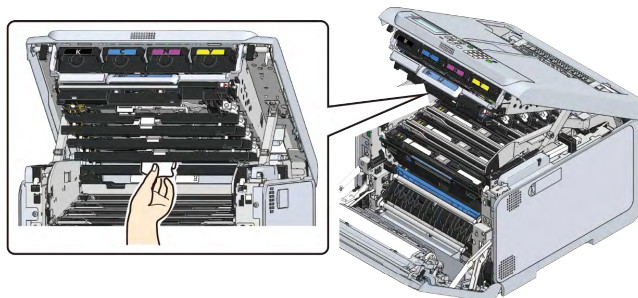

6 Close the output tray, and push both sides down from top.

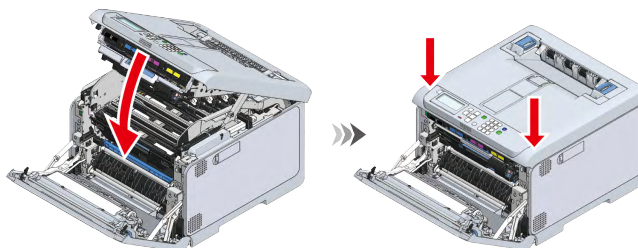

7 Press the L1 lever all the way in.

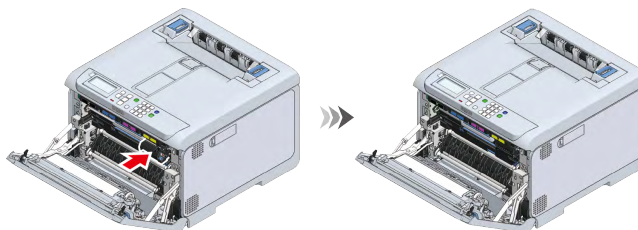

8 Close the front cover firmly with both hands.

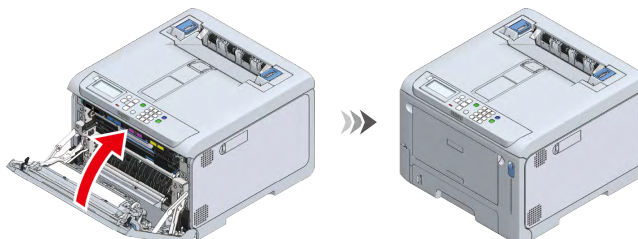

Cleaning the surface of the main unit



- Do not use benzene, paint thinner or alcohol as it may damage plastic parts and coating of this machine.
- It is not necessary to lubricate the parts of this machine. Do not lubricate.

1 Power off this machine.

- 2** Clean the surface of this machine with a cloth slightly moistened with water or a neutral detergent.



- Only use water or a neutral washing agent.

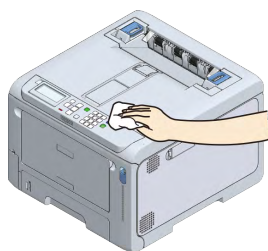

- 3** Wipe the surface of this machine with a soft dry cloth.

Cleaning paper feed rollers (Trays 1-4)

If paper jams occur frequently, clean the paper feed roller. Clean the separation roller of the paper cassette and the paper feed roller inside this machine.



- If paper jams persist even after the paper feed roller is cleaned, it is recommended to replace the paper feed roller. The following procedure takes Tray 1 for example. You can follow the same procedure to clean paper feed rollers for Tray 2, Tray 3 and Tray 4.

- 1** Pull out the paper cassette.

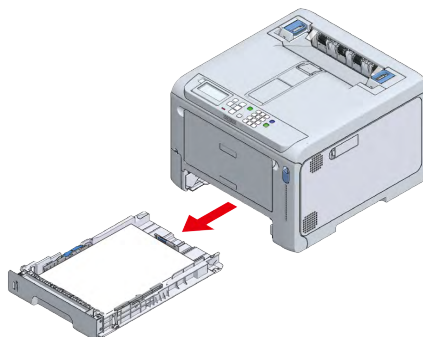

- 2** Wipe the two paper feed rollers inside this machine with a cloth slightly moistened with water.

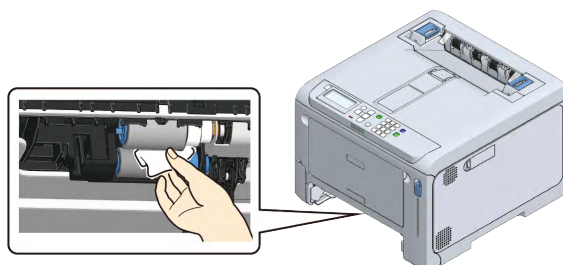

- 3** Remove the paper from the paper cassette.

- 4 Wipe the separation roller of the cassette with a cloth slightly moistened with water.

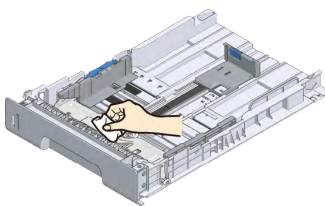

- 5 Load the paper in the paper cassette.
6 Return the paper cassette to this machine.

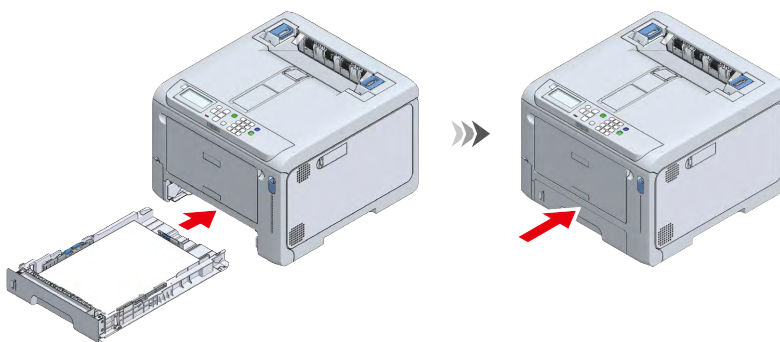

Cleaning the paper feed roller (MP tray)

If paper jams occur frequently, clean the paper feed roller.



- If paper jams persist even after the paper feed roller is cleaned, it is recommended to replace the paper feed roller.

- 1 Place your fingers in the front recess and pull to open the MP tray towards you.

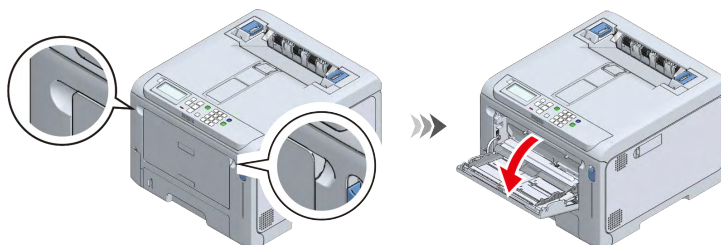

- 2 Slide the manual feeder guide inward.

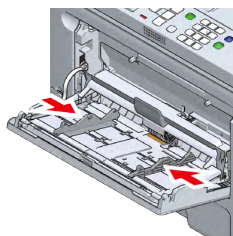

- 3 While lifting the MP tray gently, press the right arm inwards and remove the protrusion of the arm from the groove.

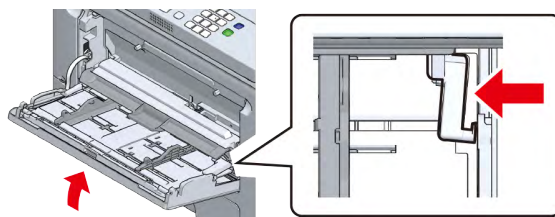

- 4 Lower the MP tray, and lift up the protrusion of the arm.

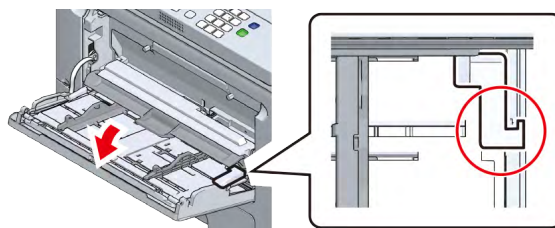

- 5 By referring to Steps 3 and 4, remove the protrusion of the left arm of the MP tray from the groove and lift it up.

- 6 Lift up the paper placement cover until it attaches to the machine.

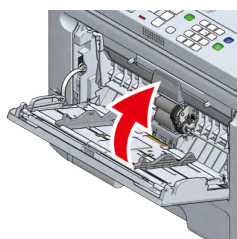

- 7 Press down on the center of the MP tray, and then press and hold the white part which is visible through the small window at the bottom of the separation roller cover. Remove the lower paper feed roller (without gear) by expanding the side protrusion outward and sliding it to the left.

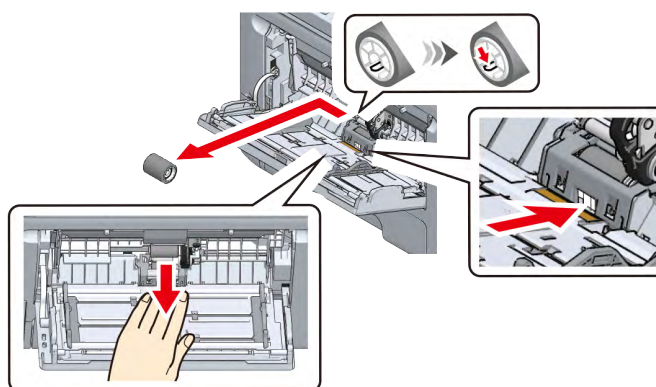

- 8** Press down on the center of the MP tray, place your finger over the small window on the separation roller cover and push it up to remove the separation roller.

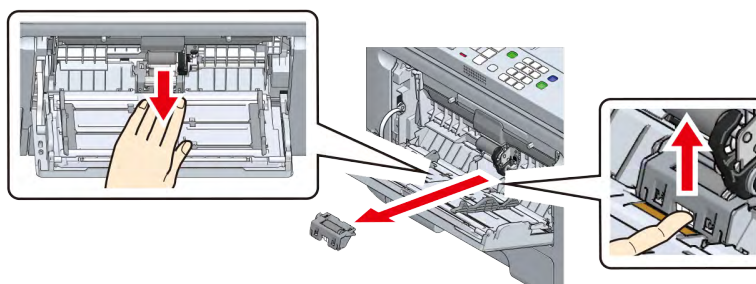

- 9** Wipe the separation roller with a cloth slightly moistened with water (while rotating it in the arrow direction).

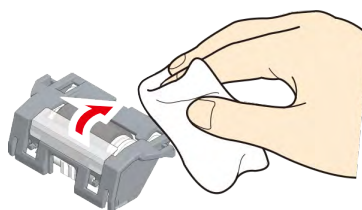

- 10** Press down on the center of the MP tray until the left trapezoidal part of the separation roller cover fits into the groove on the machine.

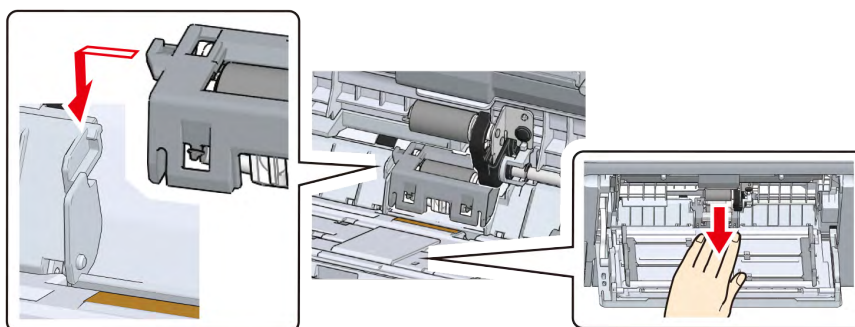

- 11** Ensure that the separation roller is in a horizontal position, and then push both ends of the separation roller cover down at the same time.



- Do not touch the rubber portion of the roller.

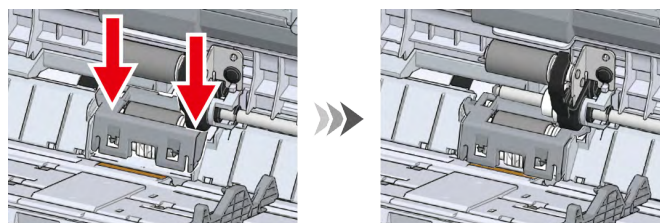

- 12** Press down on the center of the MP tray, and then press and hold the white part which is visible through the small window at the bottom of the separation roller cover. With the protrusion side on the left, install the paper feed roller (without gear) onto the lower shaft by sliding it into the innermost position.

If it is hard to insert, slide to install the paper feed roller (without gear) while rotating it downward.

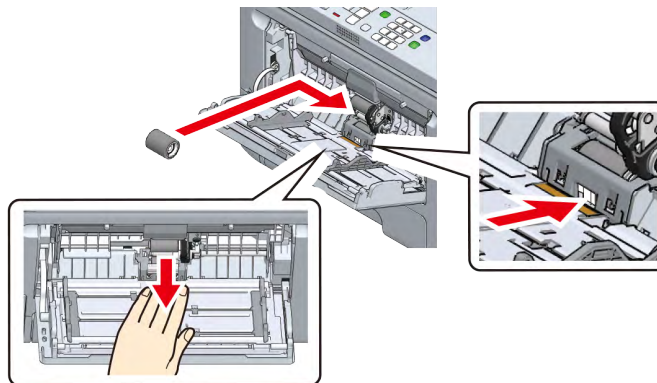

- 13** Wipe the paper feed roller (without gear, with gear) with a cloth slightly moistened with water.



- If it is hard to wipe the paper feed roller (without gear), wipe it while pressing down on the center of the MP tray and then pushing the white part which is visible through the small window at the bottom of the separation roller cover.

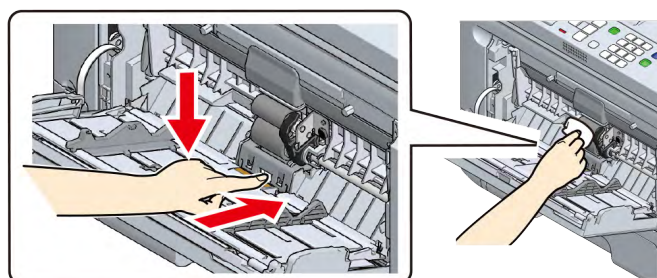

- 14** Move the paper placement cover downward.

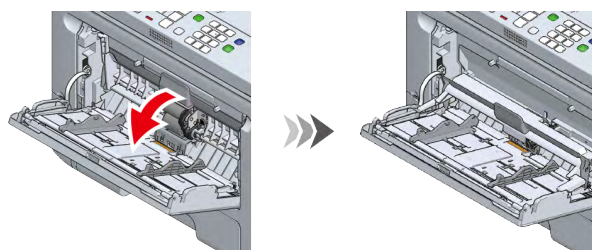

- 15** While pressing the right arm of the MP tray inwards, lift the MP tray lightly and hook the protrusion of the arm into the groove.



- If you close the MP tray without hooking the protrusion of the arm to the correct position, the paper placement cover may be broken. Be sure to hook it in the correct position.

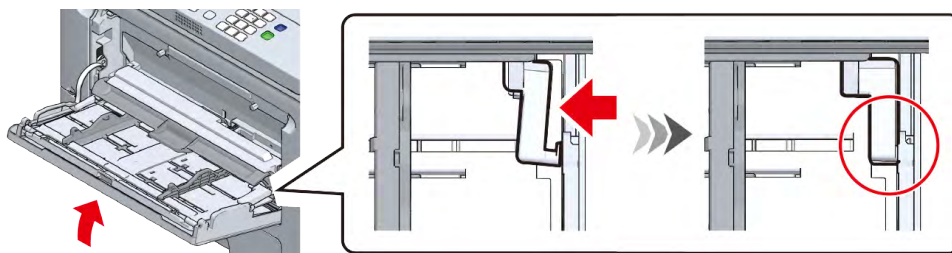

- 16** Similarly, hook the protrusion of the left arm of the MP tray into the groove.



- If you close the MP tray without hooking the protrusion of the arm to the correct position, the paper placement cover may be broken. Be sure to hook it in the correct position.

- 17** Slide the manual feeder guide outward.

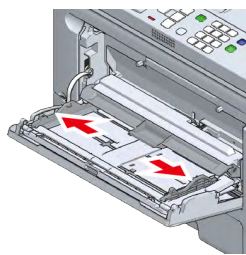

- 18** Close the MP tray.

If the MP tray does not close, check by following Steps 14 through 17.

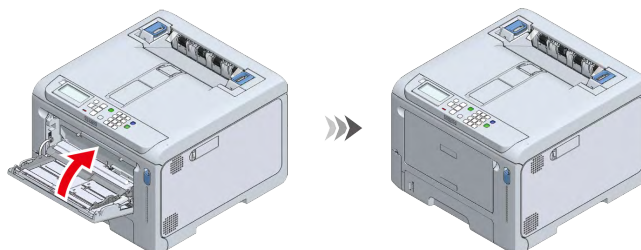

Cleaning the light-shielding film

When streaks appear on the printing result, clean the light-shielding film of the image drum to improve the printing.

- 1** Remove the black(K) image drum from this machine.
[Replacing the image drum\(P.128\)](#)
- 2** Make sure that the color label of the image drum is on the right side.
- 3** Wipe the light-shielding film with soft tissue paper.

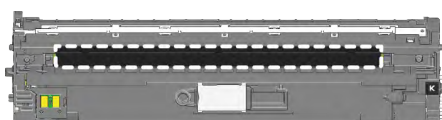

- 4 Install the image drum to this machine.
[Replacing the image drum\(P.128\)](#)
- 5 Clean the light-shielding film of other image drums as well.

Cleaning the resist roller

When horizontal streaks appear on the printing result, clean the resist roller to improve the printing.

- 1 Pull the front cover open lever (blue) to open the front cover.

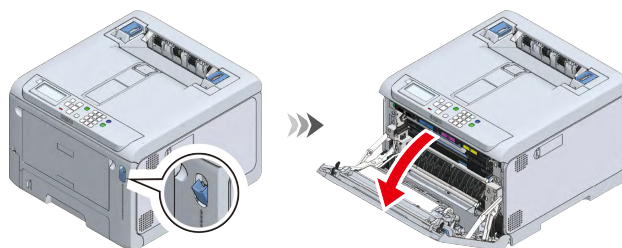

- 2 Wipe the metal parts (a) and (b) of the resist roller visible on the front with soft tissue paper.

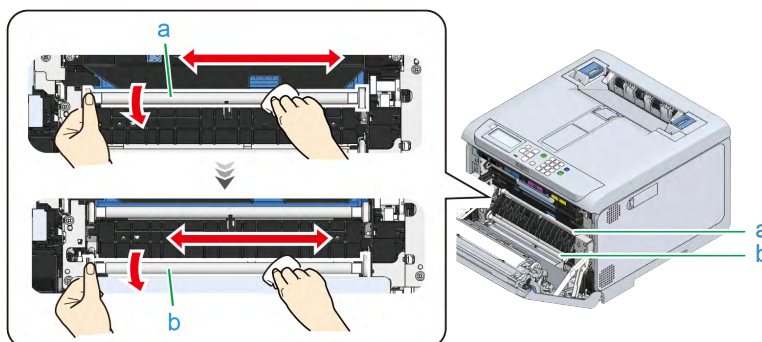

- When cleaning the metal part (b), do not touch the rubber roller in contact with the metal part (a).

- 3 Rotate the metal part downward, and repeat wiping until dirt is removed.
- 4 Close the front cover firmly with your both hands.

8 Troubleshooting

When an error message appears on the display 147

When paper is jammed 148

When an error message appears on the display

If a problem occurs to this machine, the ATTENTION lamp will light on or flash, and a message will appear on the display.

Check the message on the display and take action based on the corresponding message.

If [Please see HELP for details] appears at the bottom of the display, press «HELP» on the operator panel to show the solution. (If there is no indication, pressing «Help» will not change the indication on the display.)



- If a search keyword is displayed, you can search for a solution by inputting it in [Search Keyword] of "Frequently Asked Questions (FAQs)" on the website or your smartphone application.
- If a search keyword is displayed when the NFC function is enabled, the solution is displayed on this machine when the NFC mark on the operator panel is brought close to a device with the NFC function. Please see "Showing troubleshooting tips on a mobile device (User's Manual)" for details.

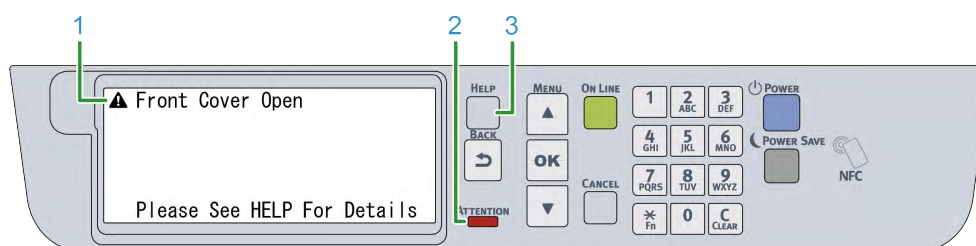

1	Display message
2	ATTENTION lamp
3	«HELP» button

Displayed when «HELP» is pressed

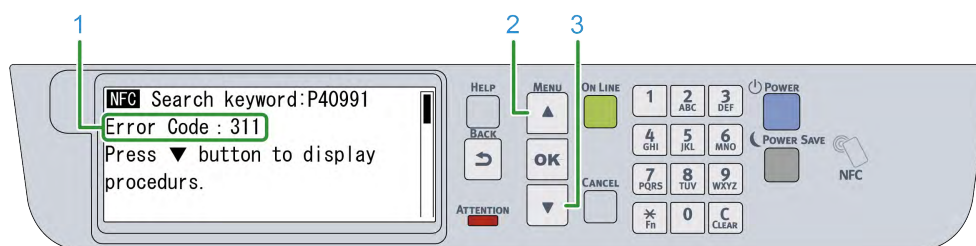

1	Error code
2	Scrolls up the display
3	Scrolls down the display

When paper is jammed

For the error code 370 or 371

- 1 Remove the jammed paper from the output exit.

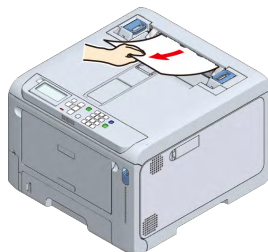

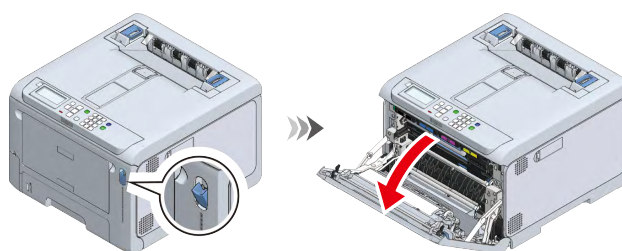

- 2 Pull the front cover open lever (blue) to open the front cover.

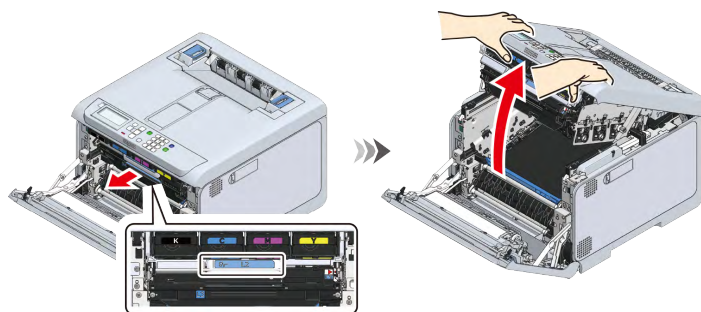

- 3 Pull the L2 lever and lift the output tray until it reaches the stop position.



- 4 Remove the paper left on the belt unit if any.

 CAUTION	Doing so may cause burns.	
Do not touch the fuser unit because it is hot.		



- Because image drums (green parts) can easily get damaged, handle with adequate care.
- Do not expose the image drum to direct sunlight or strong light (About 1,500 lux or above). Do not leave it uncovered for more than 5 minutes even under room lighting.

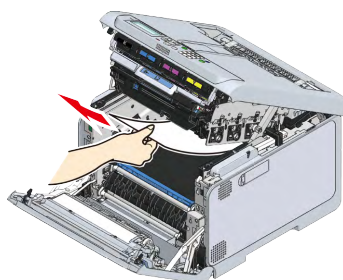

- 5 Lift the belt unit up by holding its handle.

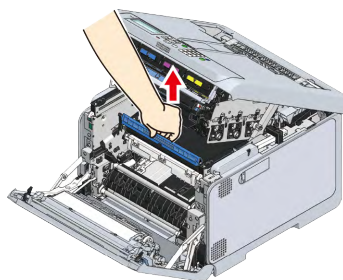

- 6 Remove the paper left under the belt unit if any.

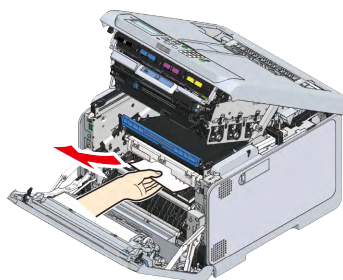

- 7 Reset the belt unit.

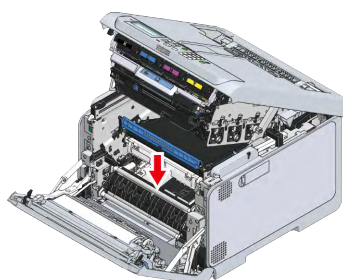

- 8 Close the output tray, and push both sides down from top.

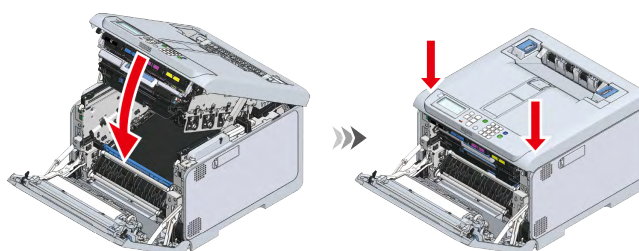



- 9 Lift the left and right handles of the fuser unit at the back of the output tray until a click is heard, and then release the lock.

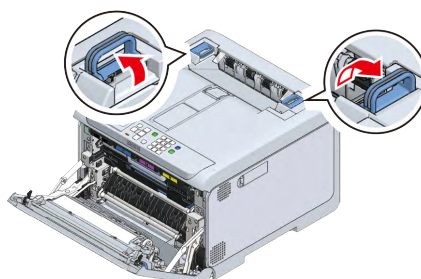

- The fuser unit cannot be removed unless its handle is raised vertically.



10 Remove the fuser unit from this machine by holding its left and right handles.

 CAUTION	Doing so may cause burns.	
When the fuser unit is hot, wait until it cools down before any operation.		



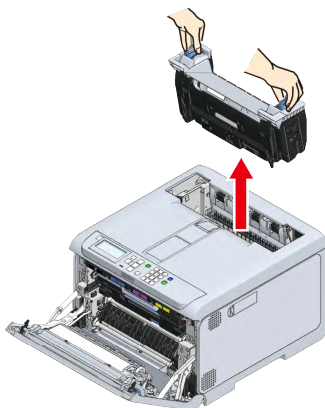

- Do not expose this machine with the fuser unit removed to direct sunlight or strong light (About 1,500 lux or above). Do not leave it uncovered for more than 5 minutes even under room lighting.

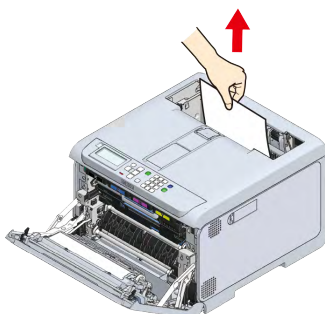

11 Remove any paper left in the machine.



12 If paper is jammed in the fuser unit, with the warning label of the fuser unit facing you, slowly pull out the jammed paper towards you.

 CAUTION	Doing so may cause burns.	
When the fuser unit is hot, wait until it cools down before any operation.		



- Do not pull it out in the reverse direction.

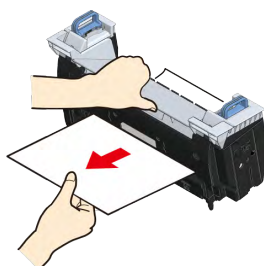

13 With the warning label of the fuser unit facing you, hold both the left and right handles.

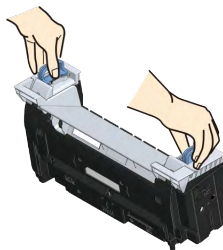

14 Place the fuser unit in this machine, tilt its left and right handles inward, and lock the fuser unit.



- Make sure that the fuser unit does not float from the top of the output tray. If floating, the fuser unit will not be recognized so that it is not possible to start printing.

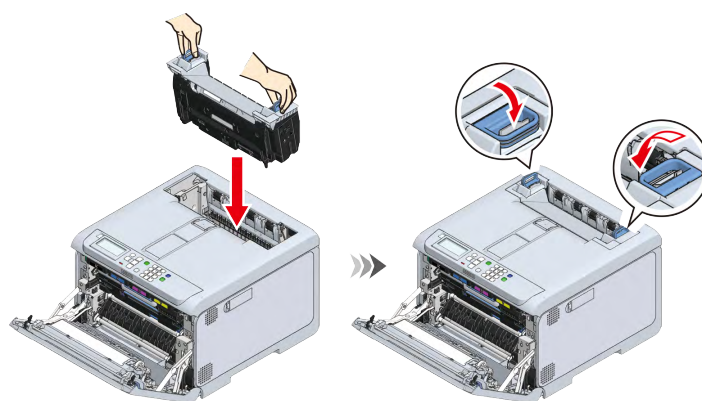

15 Close the front cover firmly with both hands.

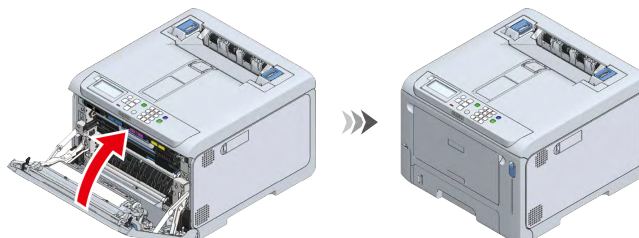

For the error code 372

1 Remove the jammed paper from the output exit.

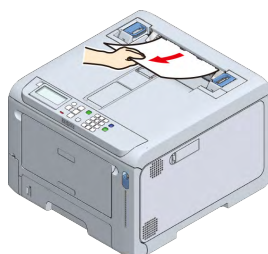

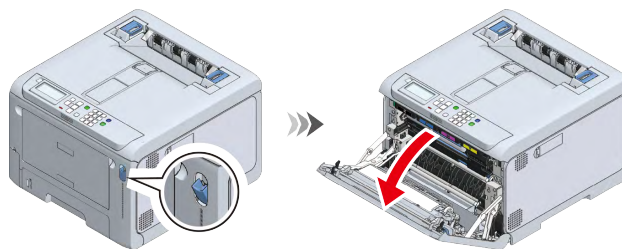

- 2 Pull the front cover open lever (blue) to open the front cover.

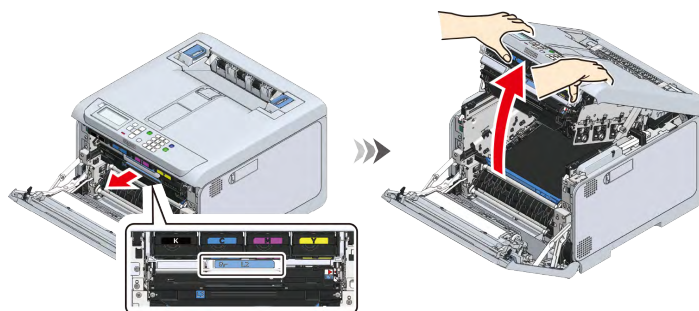

- 3 Pull the L2 lever and lift the output tray until it reaches the stop position.



- 4 Remove the paper left on the belt unit if any.

 CAUTION	Doing so may cause burns.	
Do not touch the fuser unit because it is hot.		



- Because image drums (green parts) can easily get damaged, handle with adequate care.
- Do not expose the image drum to direct sunlight or strong light (About 1,500 lux or above). Do not leave it uncovered for more than 5 minutes even under room lighting.

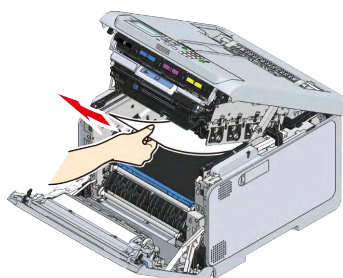

- 5 Lift the belt unit up by holding its handle.

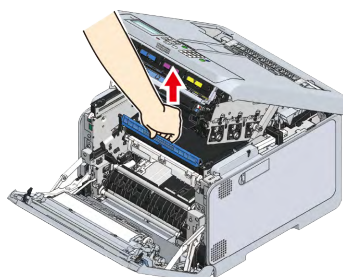

- 6 Remove the paper under the belt unit if any.

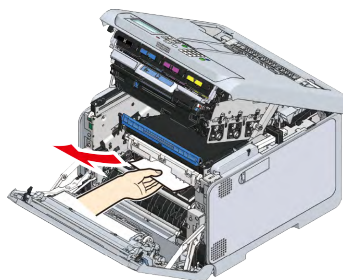

- 7 Reset the belt unit.

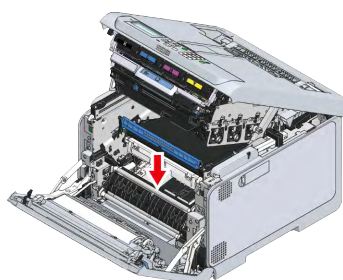

- 8 Close the output tray, and push both sides down from top.

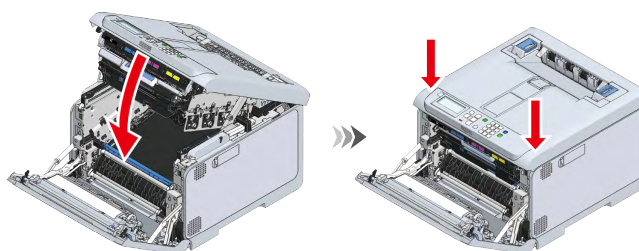

- 9 Close the front cover firmly with both hands.

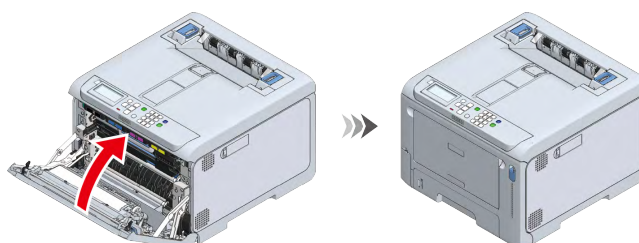

For the error code 380

- 1 Pull the front cover open lever (blue) to open the front cover.

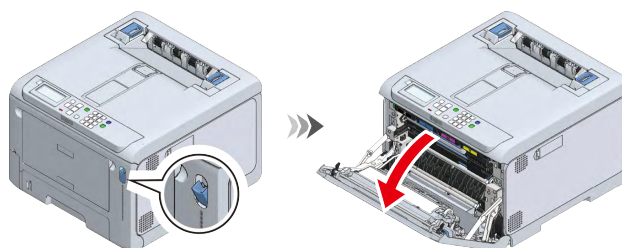

- 2 Pull out the jammed paper gently.

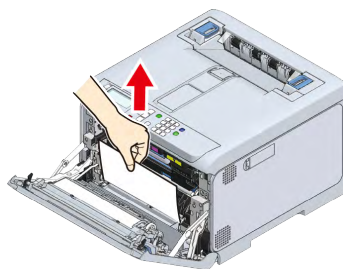

- 3 Close the front cover firmly with both hands.

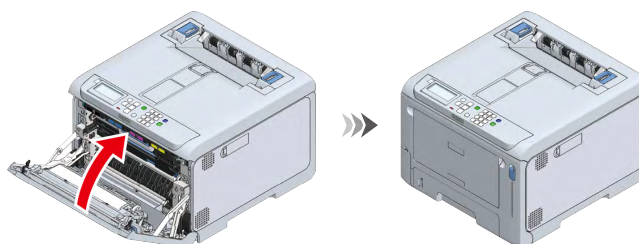

For the error code 381

- 1 Remove the jammed paper from the output exit.

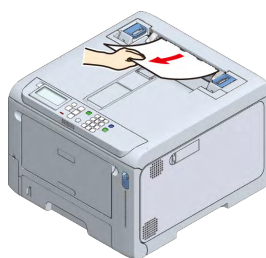

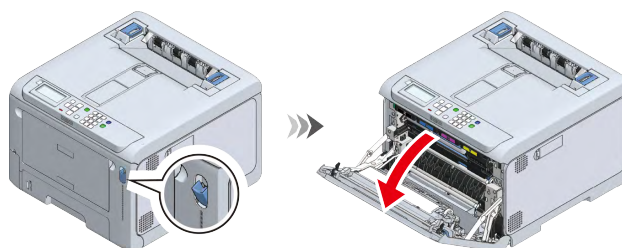

- 2 Pull the front cover open lever (blue) to open the front cover.

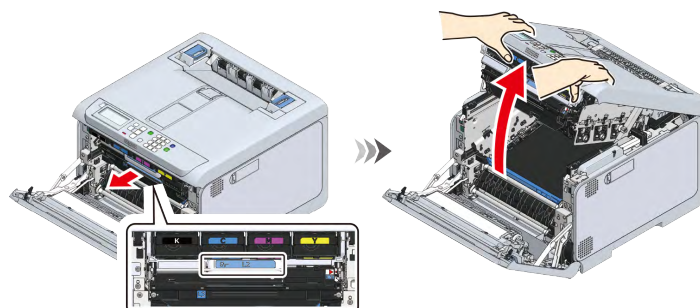

- 3 Pull the L2 lever and lift the output tray until it reaches the stop position.



4 Remove the paper on the belt unit if any.

 CAUTION	Doing so may cause burns.	
Do not touch the fuser unit because it is hot.		



- Because image drums (green parts) can easily get damaged, handle with adequate care.
- Do not expose the image drum to direct sunlight or strong light (About 1,500 lux or above). Do not leave it uncovered for more than 5 minutes even under room lighting.

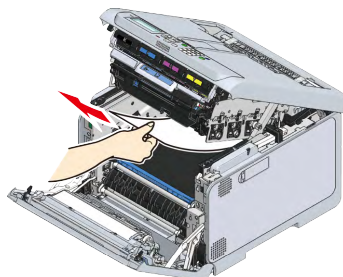

5 Close the output tray, and push both sides down from top.

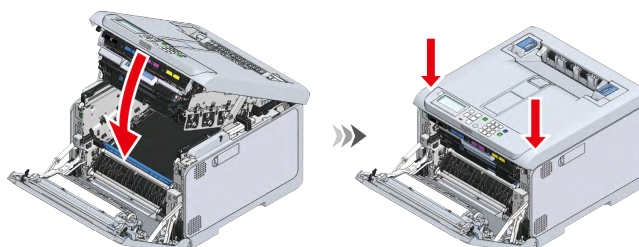

6 Close the front cover firmly with both hands.

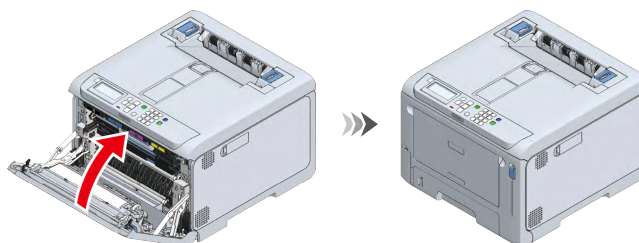

For the error code 382 or 385

1 Remove the jammed paper from the output exit.

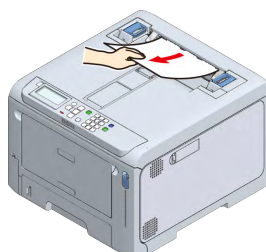

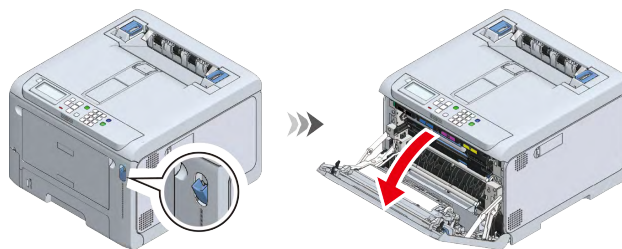

- 2 Pull the front cover open lever (blue) to open the front cover.

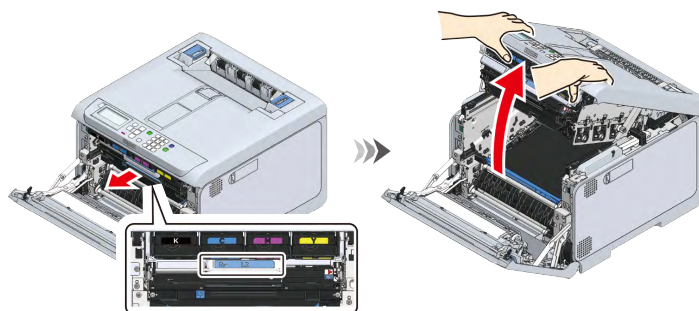

- 3 Pull the L2 lever and lift the output tray until it reaches the stop position.



- 4 Remove the paper left on the belt unit if any.

 CAUTION	Doing so may cause burns.	
Do not touch the fuser unit because it is hot.		



- Because image drums (green parts) can easily get damaged, handle with adequate care.
- Do not expose the image drum to direct sunlight or strong light (About 1,500 lux or above). Do not leave it uncovered for more than 5 minutes even under room lighting.

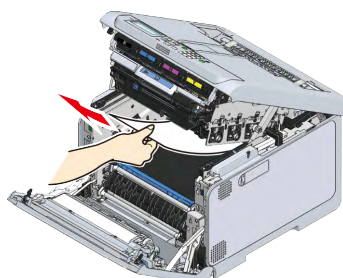

- 5 Close the output tray, and push both sides down from top.

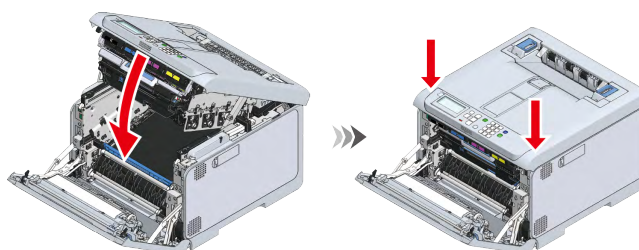



- 6 Lift the left and right handles of the fuser unit at the back of the output tray until a click is heard, and then release the lock.

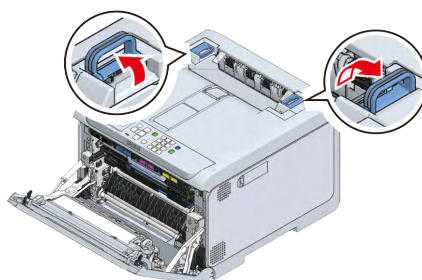

- The fuser unit cannot be removed unless its handle is raised vertically.



- 7 Holding both the left and right handles of the fuser unit, remove the fuser unit from this machine.

 CAUTION	Doing so may cause burns.	
When the fuser unit is hot, wait until it cools down before any operation.		



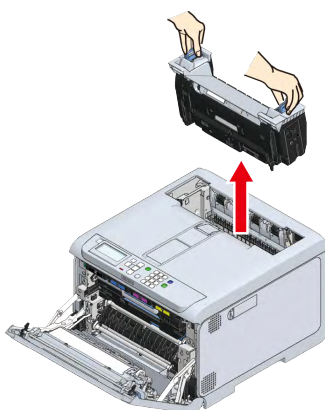

- Do not expose this machine with the fuser unit removed to direct sunlight or strong light (About 1,500 lux or above). Do not leave it uncovered for more than 5 minutes even under room lighting.

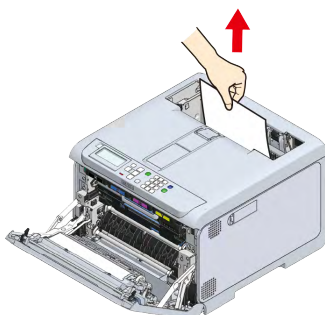

- 8 Remove any paper left in the machine.



- 9 If paper is jammed in the fuser unit, with the warning label of the fuser unit facing you, slowly pull out the jammed paper towards you.

 CAUTION	Doing so may cause burns.	
When the fuser unit is hot, wait until it cools down before any operation.		



- Do not pull out in the reverse direction.

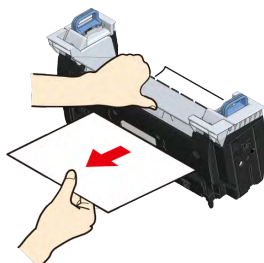

- 10 With the warning label of the fuser unit facing you, hold both the left and right handles.

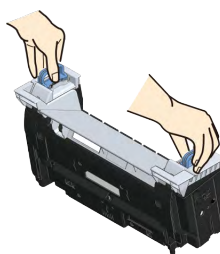

- 11 Place the fuser unit in this machine, tilt its left and right handles inward, and lock the fuser unit.



- Make sure that the fuser unit does not float from the top of the output tray. If floating, the fuser unit will not be recognized so that it is not possible to start printing.

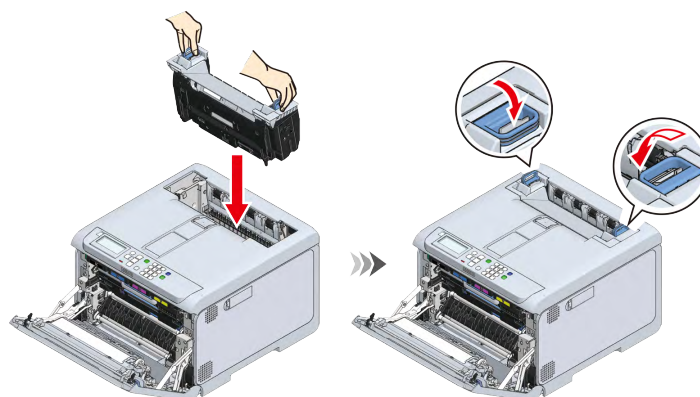

- 12 Close the front cover firmly with both hands.

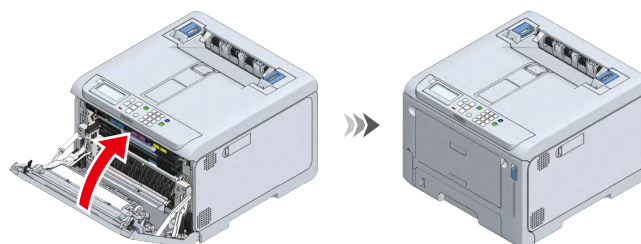

For the error code 390

- 1 Temporarily remove any paper loaded in the multi-purpose tray (MP tray).

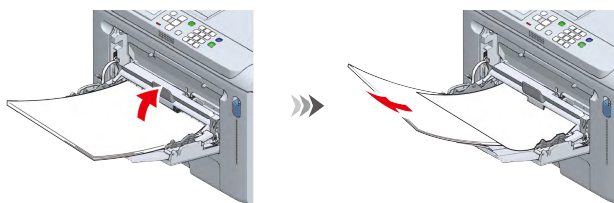

- 2 Pull the front cover open lever (blue) to open the front cover.

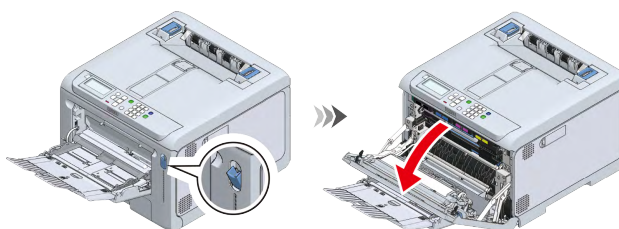

- 3 Hold the edge of the jammed paper and pull it out gently.

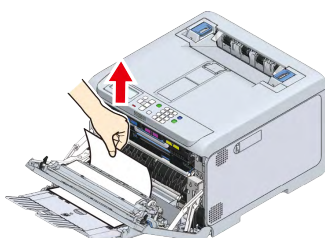

- 4 When the top edge is not visible, slowly pull out the paper from its rear edge.

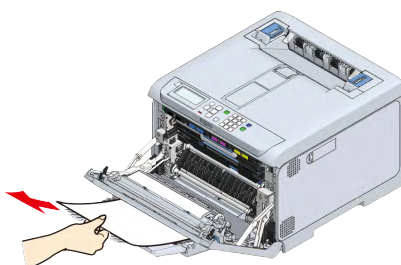

- 5 Close the front cover firmly with your both hands.

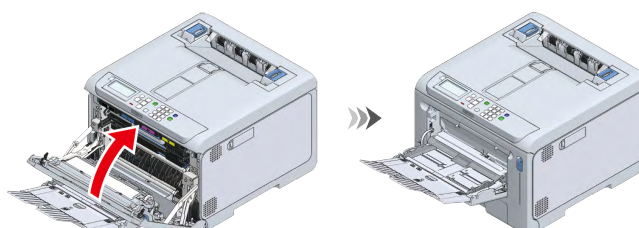

- 6 If you are using a MP tray, open the MP tray and load paper with the print side up.



- For how to load paper in the MP tray, see "[Loading paper in the MP tray\(P.78\)](#)".

For the error code 391, 392, 393 or 394

This section takes the error code 391 (indicating that the paper is jammed in Tray 1) for example. For the error code 392, 393 or 394, remove the jammed paper by following the same procedure.



- If paper jams occur frequently, clean the paper feed roller. Please see "[Cleaning paper feed rollers \(Trays 1-4\)](#)(P.139)" for details.

1 Pull out the paper cassette.

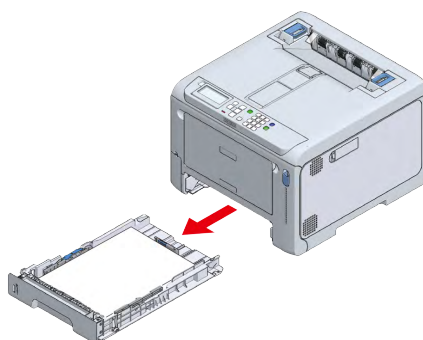

2 Remove the jammed paper.



- If no paper is jammed, feeding has failed. Reduce the number of paper loaded in the paper cassette. Also, make sure that the paper stopper position matches the paper size.

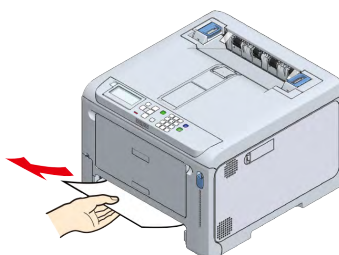

3 Return the paper cassette to this machine.

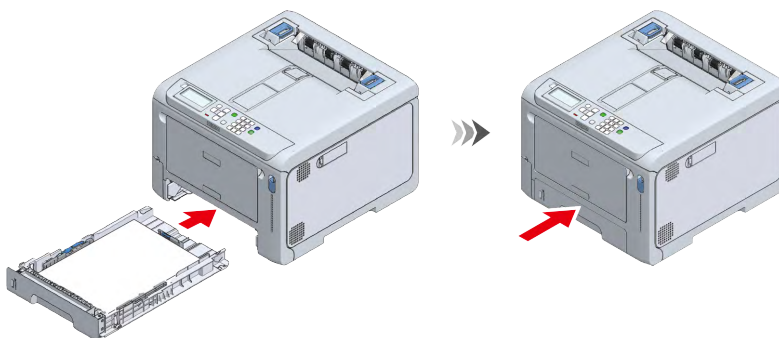

4 Open and close the front cover.



- Error cannot be cleared without opening and closing the front cover.

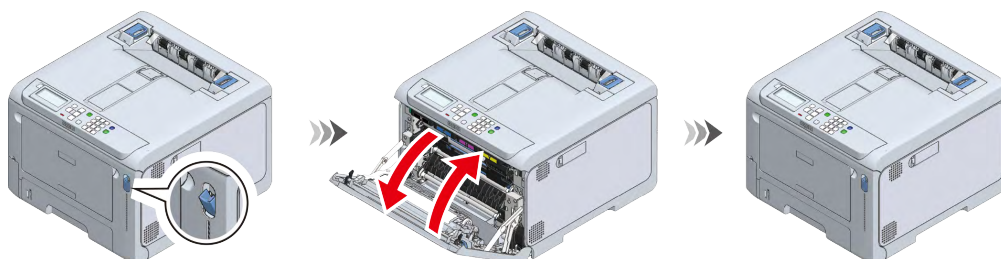

For the error code 638

First, check all the trays and remove the remaining paper. Then, remove the remaining paper inside the machine.

This section explains how to remove the paper from Tray 2 as an example.

- 1 Pull out the paper cassette.

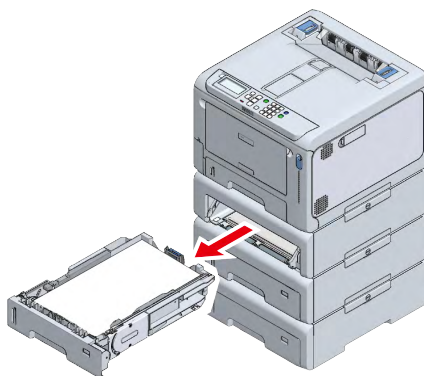

- 2 Remove the remaining paper.

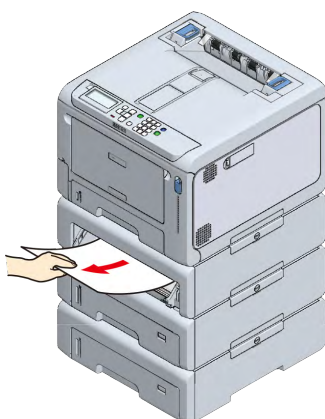

- 3 Return the paper cassette to this machine.

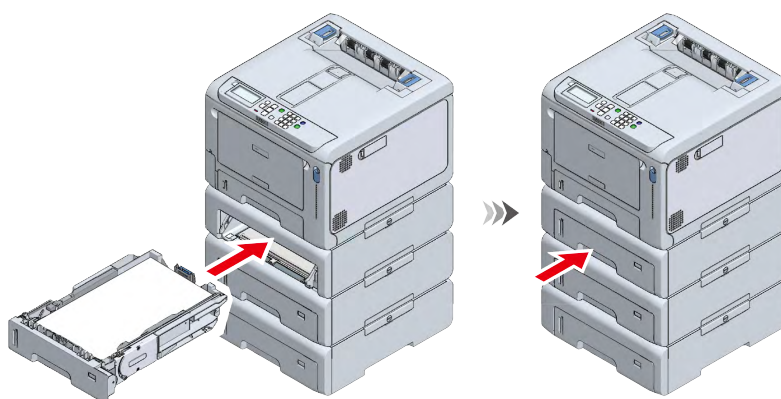

- 4 For all trays, repeat Steps 1 - 3 to remove the remaining paper.

- 5 Pull the front cover open lever (blue) to open the front cover.

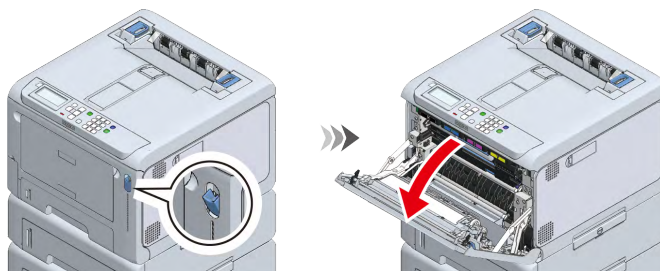

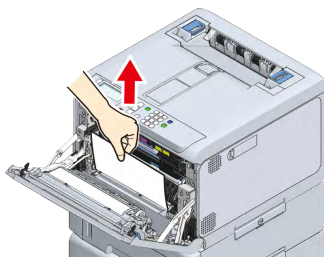

- 6 Pull out the jammed paper slowly if any.

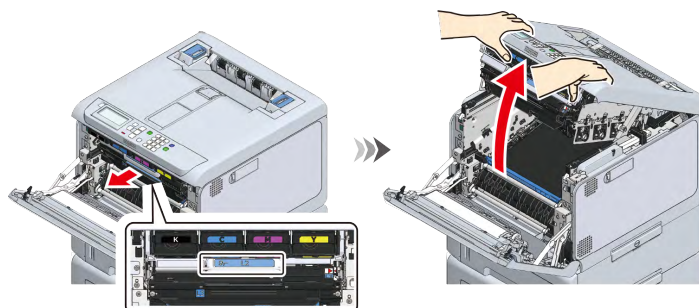

- 7 Pull the L2 lever and lift the output tray until it reaches the stop position.



- 8 Remove the paper left on the belt unit if any.

 CAUTION	Doing so may cause burns.	
Do not touch the fuser unit because it is hot.		



- Because image drums (green parts) can easily get damaged, handle with adequate care.
- Do not expose the image drum to direct sunlight or strong light (About 1,500 lux or above). Do not leave it uncovered for more than 5 minutes even under room lighting.

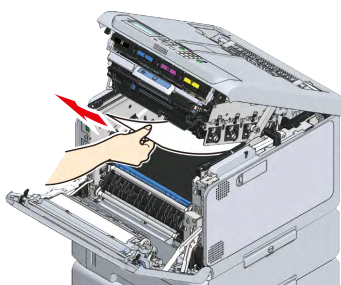

- 9 Lift the belt unit up by holding its handle.

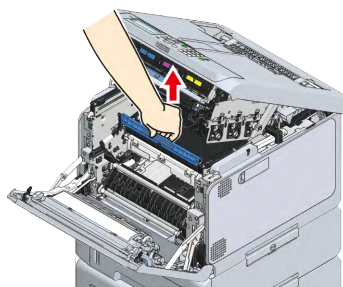

- 10 Remove the paper left under the belt unit if any.

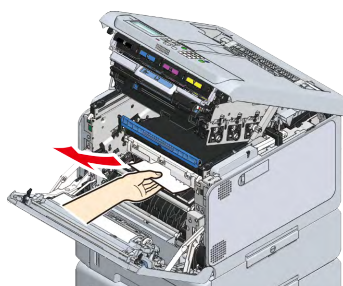

- 11 Reset the belt unit.

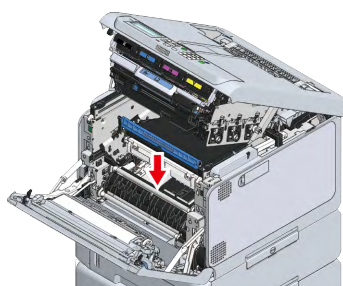

- 12 Close the output tray, and push both sides down from top.

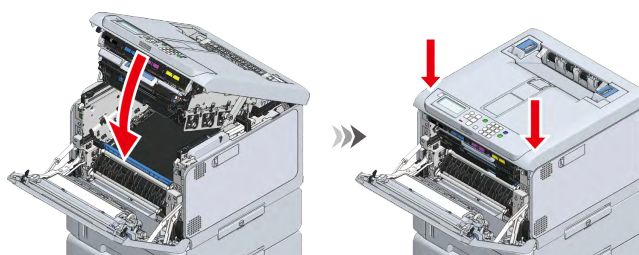



- 13 Lift the left and right handles of the fuser unit at the back of the output tray until a noise is heard, and then release the lock.

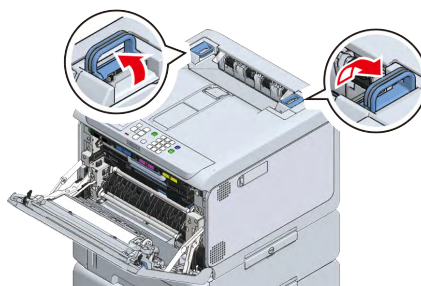

- The fuser unit cannot be removed unless its handle is raised vertically.



14 Holding both the left and right handles of the fuser unit, remove the fuser unit from this machine.

 CAUTION	Doing so may cause burns.	
When the fuser unit is hot, wait until it cools down before any operation.		



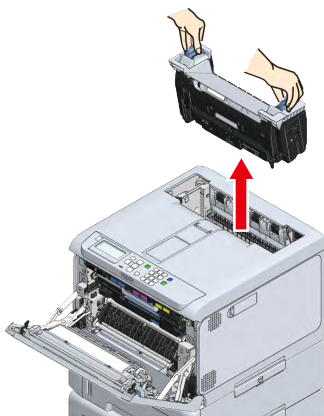

- Do not expose this machine with the fuser unit removed to direct sunlight or strong light (About 1,500 lux or above). Do not leave it uncovered for more than 5 minutes even under room lighting.



15 Remove the paper left in the machine if any.

16 If paper is jammed in the fuser unit, with the warning label of the fuser unit facing you, slowly pull out the remaining paper towards you.

 CAUTION	Doing so may cause burns.	
When the fuser unit is hot, wait until it cools down before any operation.		



- Do not pull out in the reverse direction.

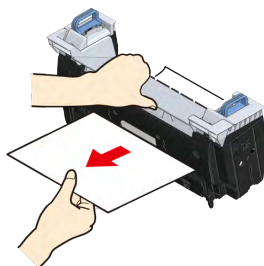

17 With the warning label of the fuser unit facing you, hold both the left and right handles.

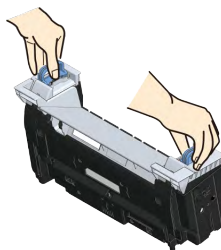

18 Place the fuser unit in this machine, tilt its left and right handles inward, and lock the fuser unit.



- Make sure that the fuser unit does not float from the top of the output tray. If floating, the fuser unit will not be recognized so that it is not possible to start printing.

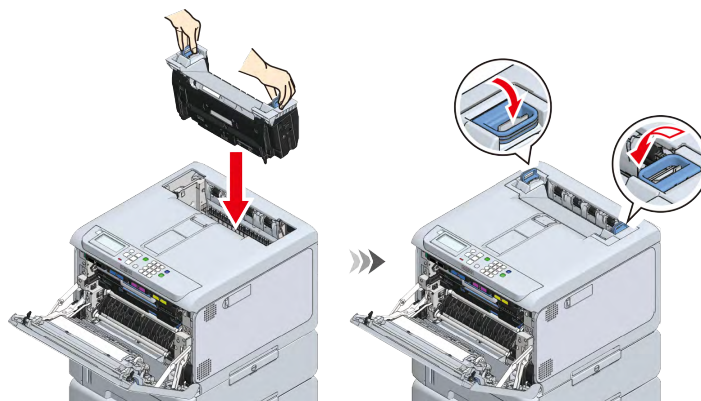

19 Close the front cover firmly with both hands.

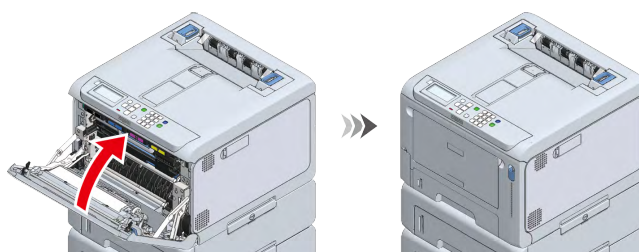

Appendix

Specifications 167

Dimensions..... 171

Menu tree 173

Specifications

Model	Model Number
C650, ES6450	N36800A, N36800B

General specifications

Item	C650/ES6450	
CPU	ARM processor (667 MHz)	
Memory	Built-in	DDR3 32bit 1GB
Weight (with consumables)	Approx. 28 kg	
Dimensions (WxDxH)	395 × 430 × 290 mm	
Power	N36800A: 110V - 127V AC +/-10% N36800B: 220V - 240V AC +/-10%	
Power consumption (of the main unit only)	Operating	840 W
	Standby	20 W (Average)
	Peak	1,150 W
	Power save mode	Less than 14 W
	Sleep mode	N36800A: Less than 0.8W*1 N36800B: Less than 1.1W*1
Operating environment conditions	Operating	Temperature: 10°C - 32°C; Humidity: 20% - 80% RH
	Pause	Temperature: 0°C - 43°C; Humidity: 10% - 90% RH
Interface	USB 2.0, Ethernet 10BASE-T/100BASE-TX/1000BASE-T, USB 2.0 Host, IEEE802.11 a/b/g/n Wireless LAN	
Display screen	2.9-inch monochrome graphic panel, 320 x 128 dots	
Compatible OS	Windows 10/Windows 8.1/Windows 8/Windows 7 Windows Server 2019/Windows Server 2016/Windows Server 2012 R2/Windows Server 2012/Windows Server 2008 R2/Windows Server 2008 macOS X 10.11 - 10.15	
Service life*2	5 years or 600,000 sheets	
Storage environment	Temperature: -10°C - 43°C Relative humidity: 10% - 90%	

*1: The default setting. It may vary with the specific settings.

*2: The service life of this machine depends on the specific usage.

Printing specifications

Item	C650/ES6450
Print method	The method of dry electrophotographic recording using LED (light-emitting diode) as exposure light source
Page description language	PCL6 (XL3.0), PCL5c, IBM5577 (H02), PostScript3, PDF (v2.0)
Resident	PCL: European 91 fonts, Japanese 4 fonts PS: European 80 fonts, Japanese 2 fonts
Resolution	600 x 600 dpi, 1200 x 1200 dpi
Print colors	Yellow, Magenta, Cyan, Black
Printing speed (A4, Portrait)	Color/Mono Simplex printing: 35 ppm Duplex printing: 18 ppm

Item		C650/ES6450
First page output time	Color	Approx. 6.5 sec (A4)
	Mono	Approx. 6.5 sec (A4)
Media Size	Tray 1	A4, A5, A6, B5, B6, Letter, Legal 13/13.5/14, Executive, Statement, 8.5-inch SQ, Folio, 16K (197 x 273 mm, 195 x 270 mm, 184 x 260 mm), 5 x 7 inches, custom sizes
	Expansion tray unit (Optional)	A4, A5, A6, B5, B6, Letter, Legal 13/13.5/14, Executive, Statement, 8.5-inch SQ, Folio, 16K (197 x 273 mm, 195 x 270 mm, 184 x 260 mm), 5 x 7 inches, custom sizes
	MP Tray	A4, A5, A6, B5, B6, B6 Half, B7, B8, Letter, Legal 13/13.5/14, Executive, Statement, 8.5-inch SQ, Folio, Index Card (3 x 5 inches), 4 x 6 inches, 5 x 7 inches, Long scale (max: 1321 mm), 16K (197 x 273 mm, 195 x 270 mm, 184 x 260 mm), C5, DL, Com-9, Com-10, Monarch, custom sizes
	Duplex printing	A4, A5, A6, B5, B6, Letter, Legal 13/13.5/14, Executive, Statement, 8.5-inch SQ, Folio, 16K (197 x 273 mm, 195 x 270 mm, 184 x 260 mm), 5 x 7 inches, custom sizes
	Custom size	<ul style="list-style-type: none"> · Tray 1 100 - 216 mm (W), 148 - 356 mm (L) · Expansion tray unit 105 - 216 mm (W), 148 - 356 mm (L) · MP tray 55 - 216 mm (W), 91 - 1321 mm (L) · Duplex 105 - 216 mm (W), 148 - 356 mm (L)
Paper quality	Plain (60 g/m ² - 256 g/m ²), Envelope, Label	
Paper feeding method	Auto paper feeding from Tray 1, the MP tray and the expansion tray unit (Optional) Manual feeding from the MP tray	
Feeding capacity	<ul style="list-style-type: none"> · Tray 1 250 sheets (80 g/m²), with the total weight of 25 mm or less · MP tray 100 sheets (80 g/m²), with the total weight of 10 mm or less; 10 envelopes (GSM paper weight: 85 g/m²) · Expansion tray unit Plain: 530 sheets (80 g/m²), with the total weight of 53 mm or less 	
Paper output method	Output tray, rear output tray	
Output capacity	<ul style="list-style-type: none"> · Output tray Plain: 150 sheets (80 g/m²) · Rear output tray Plain: 100 sheets (80 g/m²) 	
Assured printing range	6.35 mm or more from the edge of the paper (except for special paper like envelopes)	
Printing accuracy*1	Writing position accuracy: ±2 mm (±3 mm for the bottom tray when 3 expansion trays are installed); paper slant: ±1 mm/100 mm Image stretch: ±1 mm/100 mm (80 g/m ²)	
Warm-up time	<ul style="list-style-type: none"> · Power-on Approx. 20 sec or less (At room temperature 25°C and rated voltage) · When Power Save enabled Approx. 11 sec or less (At room temperature 25°C and rated voltage) Approx. 13 sec or less only for Taiwan-oriented models (At room temperature of 25°C and rated voltage) 	

Item	C650/ES6450
Print quality assurance conditions	<ul style="list-style-type: none"> · Operating range Temperature: 10°C; Humidity: 20% - 80% RH Temperature: 32°C; Humidity: 20% - 60% RH Humidity: 30% RH; Temperature: 10°C - 32°C Humidity: 80% RH; Temperature: 10°C - 27°C · Full color printing quality assurance range Temperature: 17°C - 27°C; Humidity: 50% - 70% RH
Consumables	Toner cartridge, image drum
Maintenance parts	Belt unit, fuser unit

*1: Standard-sized paper

Specifications of the expansion tray unit

Item	Expansion tray unit
Weight	Approx. 6.0 kg
Dimensions	395 mm (W) x 450 mm (D) x 139 mm (H)

Network specifications

Item	C650/ES6450
Interface	Ethernet 10BASE-T/100BASE-TX/1000BASE-T, IEEE 802.11a/b/g/n Wireless LAN
Protocol	TCP/IPv4, TCP/IPv6, NetBIOS over TCP, LPR, Port9100, IPP, FTP, HTTP, TELNET, SMTP, POP3, SNMPv1/v3, DHCP, DHCPv6, DNS, DDNS, WINS, Bonjour, SNTP, LLTD, Web Services for Devices (WSD), SSL/TLS, IPSec, LDAPv3, Kerberos, IEEE802.1X, AirPrint, HTTPS, SMTPS, POP3S, IPPS, FTPS, LDAPS

Wireless LAN specifications

Item	C650/ES6450
Wireless LAN standard	IEEE802.11a/b/g/n compliant (2.4 GHz/5 GHz)
Security	Disabled, WEP, WPA-PSK, WPA2-PSK, WPA-EAP, and WPA2-EAP

Regulatory wireless LAN statements

- FCC Statement
- IC Statement
- Europe-CE Declaration of conformity.

FCC statement

FCC WARNING

Changes or modifications not expressly approved by the party responsible for compliance could void the user's authority to operate the equipment.

Note: This equipment has been tested and found to comply with the limits for a Class B digital device, pursuant to part 15 of the FCC Rules. These limits are designed to provide reasonable protection against harmful interference in a residential installation. This equipment generates, uses and can radiate radio frequency energy and, if not installed and used in accordance with the instructions, may cause harmful interference to radio communications. However, there is no guarantee that interference will not occur in a particular installation. If this equipment does cause harmful interference to radio or television reception, which can be determined by turning the equipment off and on, the user is encouraged to try to correct the interference by one or more of the following measures:

- Reorient or relocate the receiving antenna.

- Increase the separation between the equipment and receiver.
- Connect the equipment into an outlet on a circuit different from that to which the receiver is connected.
- Consult the dealer or an experienced radio/TV technician for help.

This transmitter must not be co-located or operating in conjunction with any other antenna or transmitter.

IC statement

This device complies with Part 15 of FCC Rules and Industry Canada licence-exempt RSS standard(s). Operation is subject to the following two conditions: (1) this device may not cause interference, and (2) this device must accept any interference, including interference that may cause undesired operation of this device.

Le présent appareil est conforme aux la partie 15 des règles de la FCC et CNR d'Udustrie Canada applicables aux appareils radio exempts de licence. L'exploitation est autorisée aux deux conditions suivantes : (1) l'appareil ne doit pas produire de brouillage, et (2) l'utilisateur de l'appareil doit accepter tout brouillage radioélectrique subi, même si le brouillage est susceptible d'en compromettre le fonctionnement.

This Class [B] digital apparatus complies with Canadian ICES-003.

Cet appareil numérique de la classe [B] est conforme à la norme NMB-003 du Canada.

Caution (FCC/IC):

5.15-5.25 GHz band is restricted to indoor operations only.

La bande 5150-5250 MHz est restreints à une utilisation à l'intérieur.

This equipment complies with FCC/IC radiation exposure limits set forth for an uncontrolled environment and meets the FCC radio frequency (RF) Exposure Guidelines and RSS-102 of the IC radio frequency (RF) Exposure rules. This equipment should be installed and operated keeping the radiator at least 20 cm or more away from person's body.

Cet équipement est conforme aux limites d'exposition aux rayonnements énoncées pour un environnement non contrôlé et respecte les règles les radioélectriques (RF) de la FCC lignes directrices d'exposition et d'exposition aux fréquences radioélectriques (RF) CNR-102 de l'IC. Cet équipement doit être installé et utilisé en gardant une distance de 20 cm ou plus entre le dispositif rayonnant et le corps.

Europe - CE Declaration of Conformity



This equipment complies with the essential requirements of the European Union directive 2014/53/EU.

The telecommunications functionality of this product may be used in the following EU and EFTA countries: Austria, Belgium, Bulgaria, Cyprus, Czech Republic, Denmark, Estonia, Finland, France, Germany, Greece, Hungary, Iceland, Ireland, Italy, Latvia, Liechtenstein, Lithuania, Luxembourg, Malta, Netherlands, Norway, Poland, Portugal, Romania, Slovak Republic, Slovenia, Spain, Sweden, Switzerland, Turkey and United Kingdom.

Dimensions

Plan view

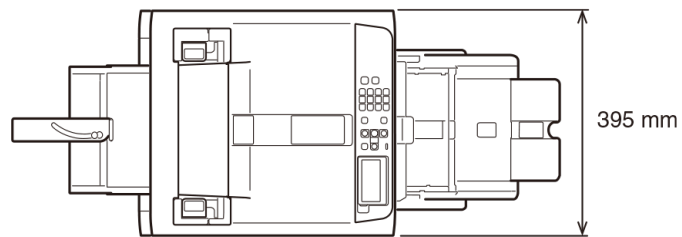

Side view

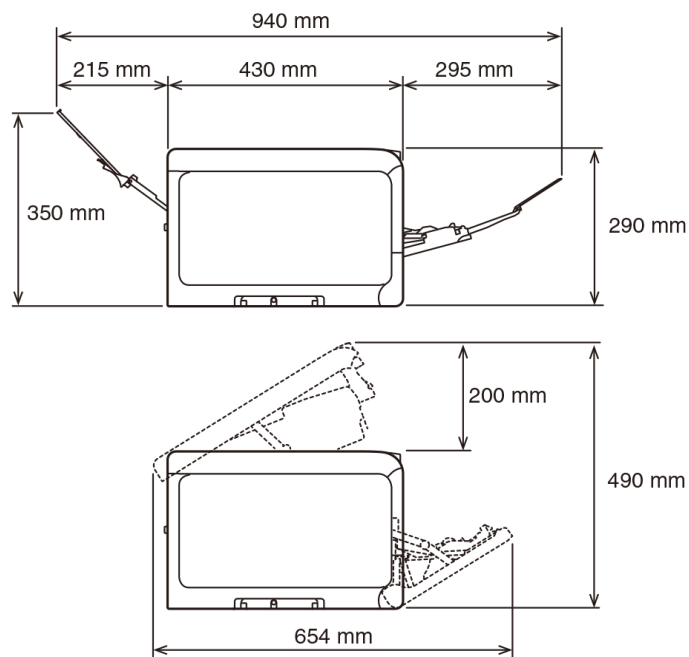

With options installed

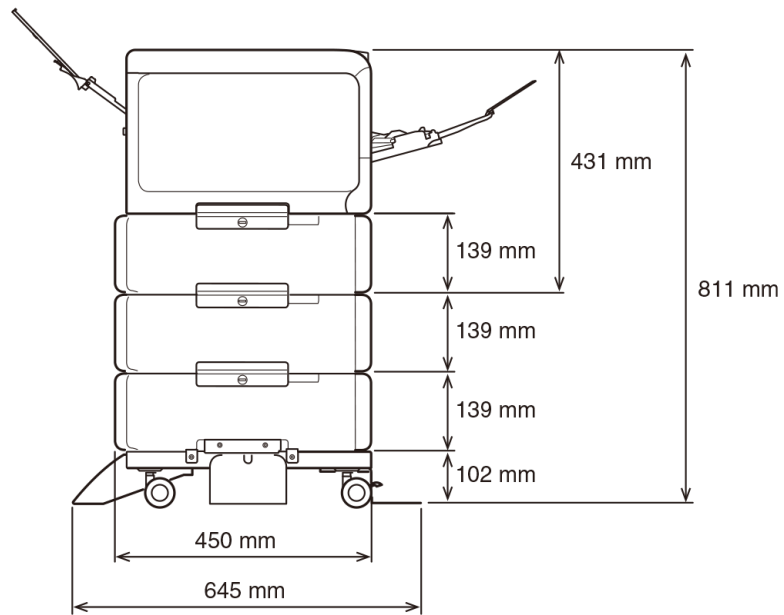
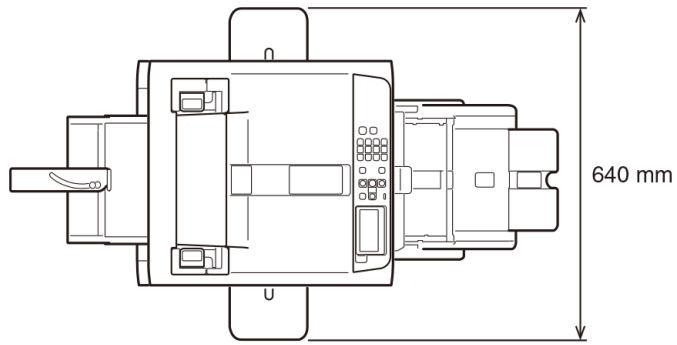

Menu tree

